

---

# OMAC



## **TECHNICAL MANUAL** **lobe pumps**



AUT. N° 810

## CONTENTS

• Hydraulic features .....	pag.	3
• B serie lobe pump code .....	pag.	4
• Overall dimensions of bare shaft pumps .....	pag.	5
• Dimensions of enlarged inlet ports ("L" version) .....	pag.	6
• Pump with heating jacket and flushed mechanical seal .....	pag.	7
• Connection types .....	pag.	8
• Standard seal for pump shafts .....	pag.	9
• Bi-lobe rotors / Pressure relief valve systems .....	pag.	10
• Selecting piping according to product viscosity and flow .....	pag.	11
• Pipe friction losses .....	pag.	12
• Conversion table for fitting and valves to equivalent pipe run .....	pag.	13
• Chart for selecting pump according to flow and product viscosity .....	pag.	14
• Chart of power correction factor as a function of viscosity .....	pag.	15
• Practical procedure for pump selection .....	pag.	16
• Instructions for reading performance charts .....	pag.	17
• Example of pump selection .....	pag.	18-19
• Water vapor pressure / temperature - specific gravity .....	pag.	20
• Calculation of NPSH available .....	pag.	21
• Pumps performances .....	pag.	22-76
• Certificate of conformity to 3A sanitary standards .....	pag.	77
• Some of our customers .....	pag.	78-79

## HYDRAULIC FEATURES

PUMP SIZE	VOLUMETRIC FLOW lt/100 rev.	MAX. SPEED r.p.m.	MAX POWER KW	MAX PRESSURE (bar)					FITTINGS STANDARD	
				ST with shaft		SM with shaft		HP Duplex + Acteon	DN	Inches
				316 S.S.	Duplex	316 S.S.	Duplex			
B100	3	1400	1,5	7	10	-	-	-	25	1"
B105	7	1000	4	10	13	15	18	-	40	1 1/2"
B110	12	1000	4	10	13	15	18	20	40	1 1/2"
B115	18	1000	5,5	7	10	12	15	-	40	1 1/2"
B215	23	950	7,5	10	13	15	18	20	40	1 1/2"
B220	34	950	7,5	7	10	12	15	-	50	2"
B325	55	720	18,5	10	13	15	18	20	65	2 1/2"
B330	70	720	18,5	7	10	12	15	-	80	3"
B430	116	600	30	10	13	15	18	20	80	3"
B440	155	600	30	7	10	12	15	-	100	4"
B470	240	500	45	10	13	15	18	20	100	4"
B490	330	500	45	7	10	12	15	-	100	4"
B550	400	500	45	5	-	7	-	-	125	5"
B660	700	500	75	7	-	-	-	-	150	6"
B680	1050	500	75	4	-	-	-	-	200	8"

AVAILABLE ROTOR TYPE	PUMP SIZES														
	B100	B105	B110	B115	B215	B220	B325	B330	B430	B440	B470	B490	B550	B660	B680
STAINLESS STEEL TRI-LOBE			●	●	●	●	●	●	●	●	●	●	●	●	●
STAINLESS STEEL GEAR ROTOR	●	●													
ACTEON DUAL WING ROTARY PISTON <sup>o</sup>	●	●	●	●	●	●	●	●	●	●	●	●	●		
ACTEON TRI-LOBE (gear rotor*)	●	●	●	●											
STAINLESS STEEL BI-LOBE	●			●		●	●	●	●	●	●	●	●		
RUBBER COATED TRI-LOBE (five-lobe*)	●	●	●	●	●	●							●	●	
RUBBER COATED BI-LOBE						●		●	●	●			●		

<sup>o</sup> Bi-lobe for B100 - \* For B100 and B105

## LIMITING DIFFERENTIAL PRESSURE AT VARYNG TEMPERATURE

TEMPERATURE °C	ROTOR TYPE	PUMP SIZES														
		B100	B105	B110	B115	B215	B220	B325	B330	B430	B440	B470	B490	B550	B660	B680
0-70°C	ST	7	10	10	7	10	7	10	7	10	7	10	7	5	7	5
	SM	-	15	15	12	15	12	15	12	15	12	15	12	7	10	7
	HP	-	-	20	-	20	-	20	-	20	-	20	-	-	-	-
90°C	ST	5,2	8,8	8,9	6,5	9	6,5	9,1	6,5	9,1	6,4	9,1	6,3	4,4	6,4	4,4
	SM	-	15	15	12	15	12	15	12	15	12	15	12	7	10	7
	HP	-	-	18,8	-	18,9	-	19	-	19	-	19	-	-	-	-
110°C	ST	4	7,6	7,8	5,7	8	5,9	8,2	6	8,4	5,8	8,4	5,9	5,8	5,8	3,9
	SM	-	15	15	12	15	12	15	12	15	12	15	12	10	10	7
	HP	-	-	17,6	-	17,7	-	18	-	18	-	18	-	-	-	-
120°C	ST	3,4	7	7,3	5,5	7,5	5,6	7,8	5,7	7,9	5,5	7,8	5,4	3,7	5,5	3,7
	SM	-	14	14,6	11,7	14,5	11,7	14,5	11,7	14,6	11,7	14,6	11,6	6,8	9,5	6,8
	HP	-	-	17,1	-	17,2	-	17,6	-	17,5	-	17,5	-	-	-	-
140°C	ST	2,2	6	6,3	5,1	6,5	5	7	5,2	7,2	4,9	7,2	4,9	3,2	4,9	3,2
	SM	-	13	13,6	11,3	13,6	11,1	13,8	11,2	13,7	11,1	13,7	11,1	6,4	8,6	6,4
	HP	-	-	16,1	-	16,3	-	16,8	-	16,6	-	16,6	-	-	-	-
160°C	ST	-	-	5,3	5	5,5	4,4	6,1	4,6	6,4	4,3	6,4	4,2	2,6	4,3	2,6
	SM	-	-	12,7	10,8	12,7	10,5	12,9	10,7	12,9	10,4	12,7	10,4	6	7,8	6
	HP	-	-	15,1	-	15,3	-	15,8	-	15,8	-	15,6	-	-	-	-
180°C	ST	-	-	4,3	4,5	4,5	3,9	5,2	4,1	5,5	3,6	5,4	3,6	2	3,6	2
	SM	-	-	12,1	9,9	11,8	10,5	12,1	10,1	12	9,7	12	9,7	5,5	6,9	5,5
	HP	-	-	14,1	-	14,3	-	14,9	-	14,9	-	14,6	-	-	-	-



# B SERIE LOBE PUMP CODE

EXAMPLE:

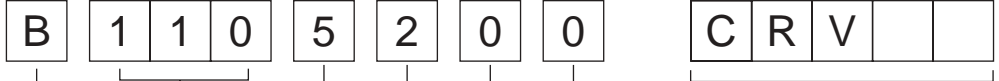

FINISHED PRODUCT  
CATEGORY  
LOBE PUMP SERIE

**B**

PUMP  
SIZE

- 100
- 105
- 110
- 115
- 215
- 220
- 325
- 330
- 430
- 440
- 470
- 490
- 550
- 660
- 680

SEAL  
TYPE

- 0 Type UM (lip seal)
- 1 Teflon packing rings
- 2 Teflon packing rings + hydraulic barrier
- 3 SS/Carbon balanced mech. seal
- 4 Tung. Carbide/Carbon balanced mech. seal
- 5 Tung. Carbide/Tung. Carbide balanced mech. seal
- 6 Ceramic/Carbon balanced mech. seal
- 7 Ceramic/Rulon balanced mech. seal
- 8 Silicon Carbide/Sil. Carbide balanced mech. seal
- 9 Special seals

SUCTION/DISCHARGE  
PORT CONNECTIONS

- |                     |                     |
|---------------------|---------------------|
| 0 Gas - BSP ports   |                     |
| 1 Flanged ports     |                     |
| 2 DIN 11851 F ports |                     |
| 3 SMS ports         |                     |
| 4 RJT (BS) ports    | 7 Female gas thread |
| 5 IDF ports         | 8 Oenological       |
| 6 Clamp ports       | 9 Special           |

ROTOR  
TYPE

- 0 Standard stainless steel tri-lobe ST
- 1 Stainless steel tri-lobe increased clearance SM
- 2 Standard stainless steel bi-lobe ST
- 3 Stainless steel bi-lobe increased clearance SM
- 4 Rubber-coated stainless steel/NBR tri-lobe
- 5 Acteon dual wing rotary piston
- 6 Rubber-coated stainless steel/NBR bi-lobe
- 7 Acteon tri-lobe/gear rotor
- 8 Stainless steel gear rotors
- 9 Special rotors

TYPE OF END  
COVER

- 0 Standard end cover
- 1 End cover with relief valve
- 2 End cover with heating jacket

SPECIAL  
VERSIONS

A Aseptic pump	M Polymer/Monel pump
B External by-pass	P Teflon trim
C Single flushed mech. seal	Q Double flushed mech. seal
D Duplex shafts	R Rotor case with heating jacket
F Polymer/Hastelloy pump	S S1 polymer lip seal
G Inner polishing surface < 0,6 μ	T Hydraulic flange pump
H High-pressure pump	U EPDM trim
I Monel 400 pump	V Viton trim
J Titanium pump	W Polymer/Titanium pump
K Surface hardening	Y Hastelloy pump
L Enlarged inlet port	Z Hastelloy/Titanium pump

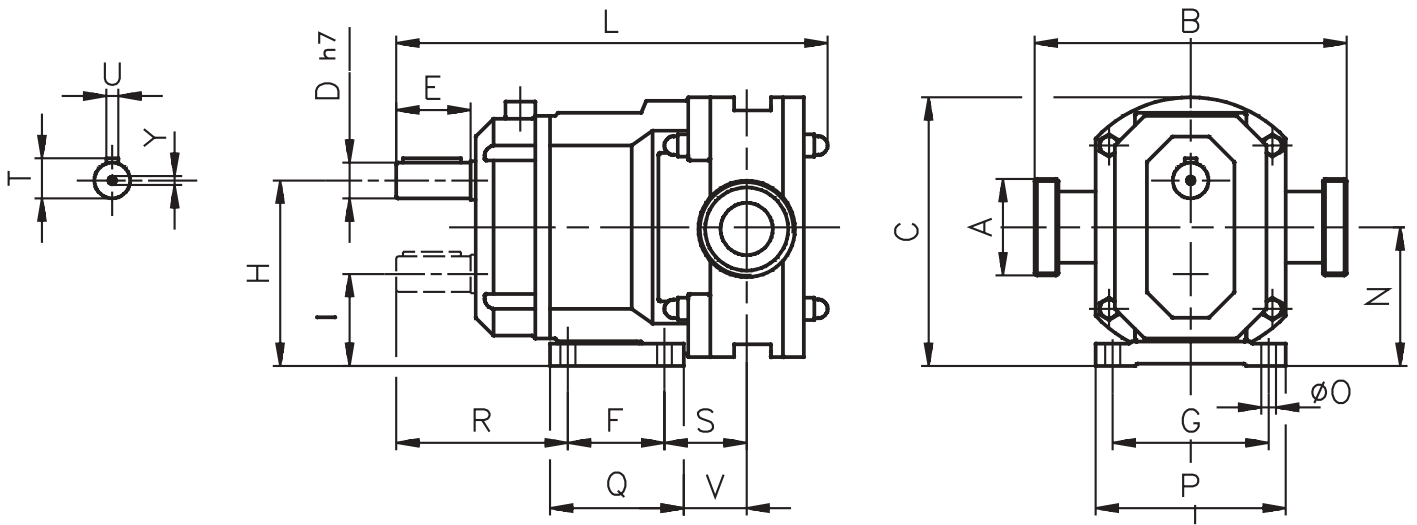

ITEM	TYPE OF PUMP WITH GAS-BSP PORTS														
	B100	B105	B110	B115	B215	B220	B325	B330	B430	B440	B470	B490	B550	B660	B680
A	1"	1 1/2"	1 1/2"	1 1/2"	1 1/2"	2"	2 1/2"	3"	3"	4"	4"	4"			
B	160	170	170	170	208	208	236	236	335	335	385	385			
C	115.5	181	181	181	235.5	235.5	270	270	367.5	367.5	442.5	442.5	515	690	690
D	18	24	24	24	28	28	35	35	48	48	55	55	55	80	80
E	45	50	50	50	55	55	65	65	85	85	110	110	110	140	140
F	65	65	65	65	90	90	120	120	140	140	150	150	200	300	300
G	105	105	105	105	125	125	140	140	190	190	250	250	300	400	400
H	80	125	125	125	165	165	190	190	255	255	300	300	350	480	480
I		62	62	62	90	90	100	100	130	130	160	160	178	250	250
L	265	290.5	290.5	302.5	365.5	380.5	459	474	543.5	543.5	654	654	637	807	867
N	58.6	93.5	93.5	93.5	127.5	127.5	145	145	192.5	192.5	230	230	264	365	365
O	9	10	10	10	12	12	14	14	18	18	22	22	19	26	26
P	125	128	128	128	152	152	174	174	235	235	300	300	350	460	460
Q	85	90	90	90	130	130	170	170	195	195	255	255	250	360	360
R	108	115.5	115.5	115.5	136.5	136.5	167	167	206.5	206.5	255	255	227	283	283
S	52	55.5	55.5	67	78	87	94	103	109	116.5	143.5	173	106.5	122	152
T	20.5	27	27	27	31	31	38.5	38.5	52	52	60	60	60	85	88
U	6	8	8	8	8	8	10	10	14	14	16	16	16	22	22
V	42	42.5	42.5	54	52	61	62	71	76.5	84	63.5	93	81.5	92	122
Y		M6	M6	M6	M8	M8	M10	M10	M12	M12	M12	M12	M12	M16	M16
Kg.	10.5	20	20	21	41	43	63	65	130	135	225	233	270	610	670
Pumps with UNI 2278 PN 16 flanged ports															
A	DN25	DN40	DN40	DN40	DN40	DN50	DN65	DN80	DN80	DN100	DN100	DN100	DN125	DN150	DN200
B	165	186	186	186	224	228	256	256	355	355	405	405	566	680	670
Pumps with DIN 11851 ports															
A	DN25	DN40	DN40	DN40	DN40	DN50	DN65	DN80	DN80	DN100	DN100	DN100	DN125		
B	160	210	210	210	248	228	296	296	395	395	445	445	632		
Pumps with SMS ports															
A	DN25	DN38	DN38	DN38	DN38	DN51	DN63	DN76	DN76	DN101	DN101	DN101			
B	143	210	210	210	248	248	296	296	395	395	445	445			
Pumps with IDF - ISS ports															
A	DN25	DN38	DN38	DN38	DN38	DN51	DN63	DN76	DN76	DN101	DN101	DN101			
B	146	210	210	210	248	248	296	276	375	378	428	428			
Pumps with RJT ports															
A	DN25	DN38	DN38	DN38	DN38	DN51	DN63	DN76	DN76	DN101	DN101	DN101			
B	157	210	210	210	248	248	290	286	385	389	439	439			
Pumps with TRI-CLAMP ports															
A	DN 1"	DN 1 1/2"	DN 1 1/2"	DN 1 1/2"	DN 1 1/2"	DN 2"	DN 2 1/2"	DN 3"	DN 3"	DN 4"	DN 4"	DN 4"			
B	160	210	210	210	248	248	293	290	389	392	442	442			

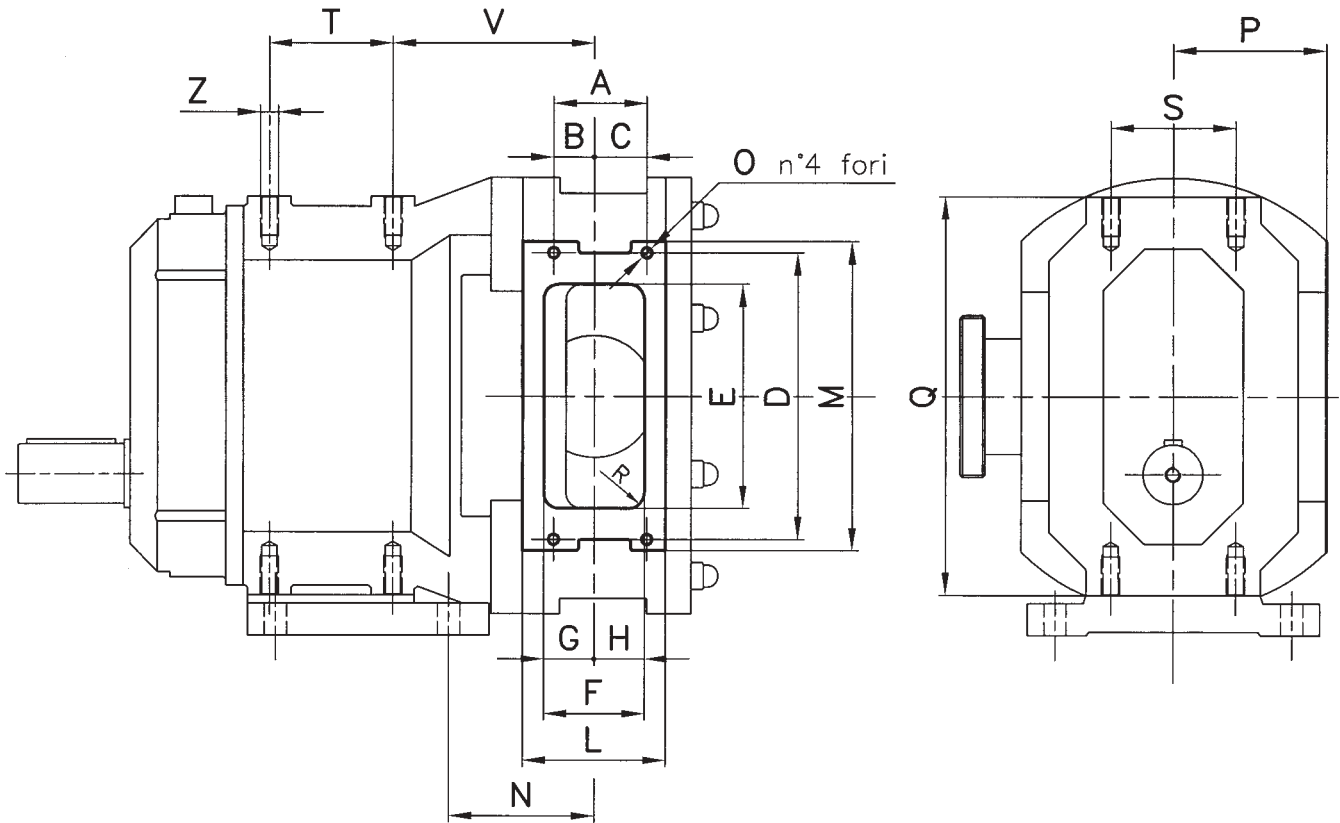

Type of pump / ITEM	A	B	C	D	E	F	G	H	L	M	N	O	P	Q	R	S	T	V	Z
<b>B115</b>	40	22	18	90	70	42	23	19	61	120	67	M6	64	154	6	55	35	94	M8
<b>B220</b>	55	31	24	110	92	54	32	22	72	150	87	M8	78	210	15	67	67	114	M10
<b>B330</b>	75	37	38	146	133	65	32	33	93	176	103	M8	95	236	12.5	70	85	143.5	M12
<b>B440</b>	75	32.5	42.5	230	180	81	40.5	40.5	115	248	116.5	M10	122.5	320	12.5	100	100	161.5	M14

**VERTICAL INSTALLATION**

For the connection with vertical axis pipes it is necessary to disassemble the pump foot (which is fixed for B100-B5-B6 models) and to fix the gearbox directly to a suitable support that can be supplied on request with the bare shaft pump or already included in the "vertical base".

In case of supply of a bare shaft pump check the correct position of the plug and of oil level.

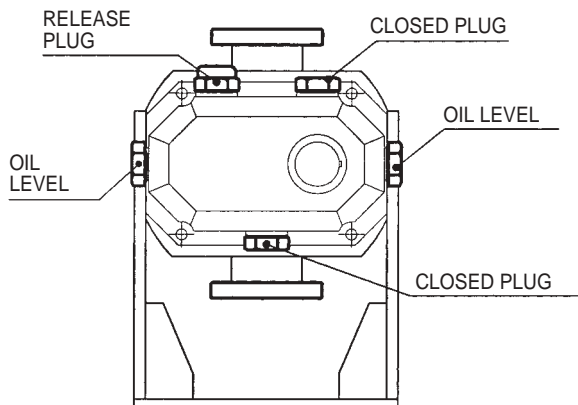

Example of vertical installation of a pump with enlarged port placed under a hopper.

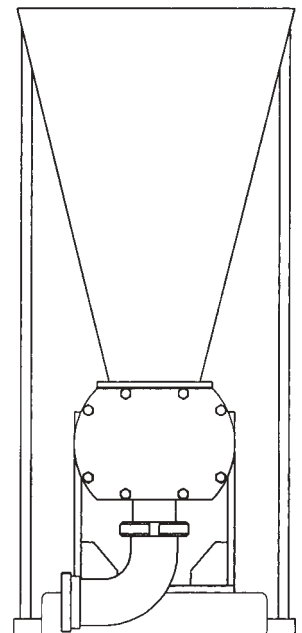

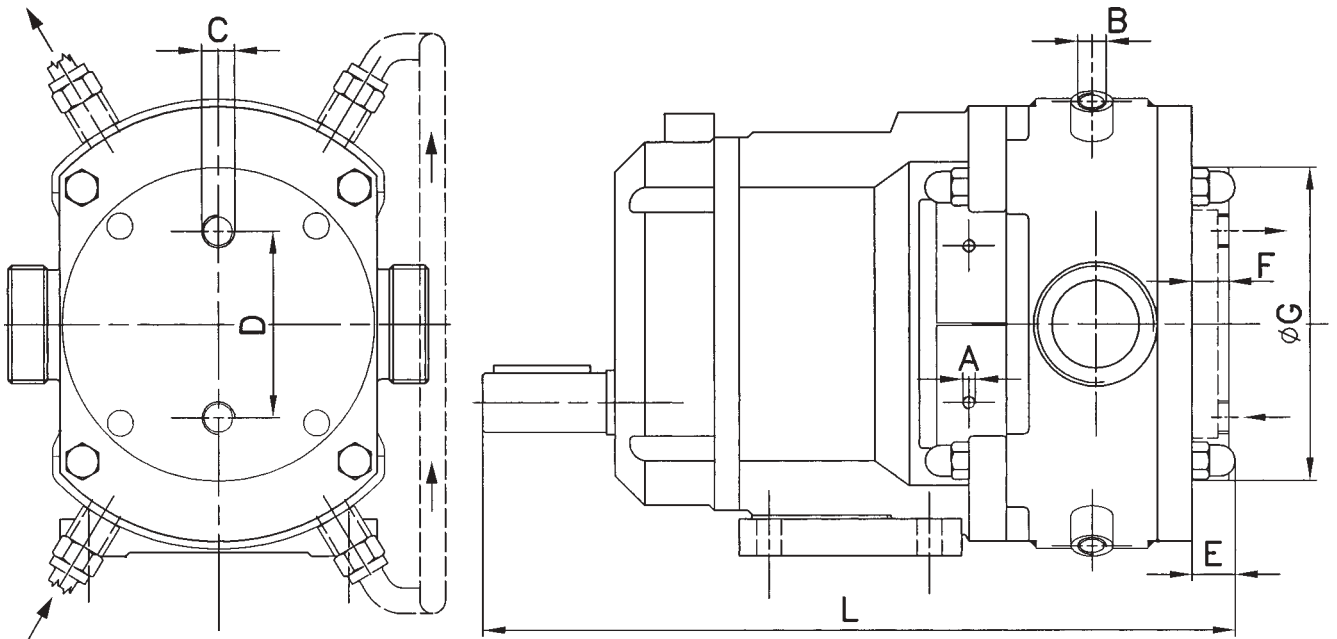

**HEATING OR FLUSHING FLUID CONNECTIONS IN INCHES GAS UNI 338**

ITEM	DESCRIPTION	TYPE OF PUMP													
		B100	B105 B110	B115	B215	B220	B325	B330	B430	B440	B470	B490	B550	B660	B680
A	Seal flushing connections size		1/8"	1/8"	1/8"	1/8"	1/8"	1/8"	1/8"	1/8"	1/8"	1/8"	1/8"	1/4"	1/4"
B	Rotor case heating fluid connections size		1/4"	1/4"	1/4"	1/4"	1/4"	1/4"	1/2"	1/2"	3/4"	3/4"	3/4"	3/4"	3/4"
C	End cover heating fluid connections size	1/8"	1/4"	1/4"	1/4"	1/4"	1/4"	1/4"	1/2"	1/2"	3/4"	3/4"	3/4"	3/4"	3/4"
D	Distance between end cover fluid connections	56	75	75	100	100	122	122	150	150	180	180	230	300	300
E	Nut height	12	15	15	18	18	18	18	22	22	25	25	24	27	27
F	End cover heating chamber thickness	17	15	15	15	15	16	16	18	18	23	23	25	30	30
G	End cover heating chamber diameter	104	126	126	156	156	179	179	219	219	280	280	300	400	400
L	Pump length	265	290.5	302.5	365.5	380.5	459	474	543.5	563.5	654	684	637	807	867

Flushing scheme for simple mechanical seals with low pressure circuit

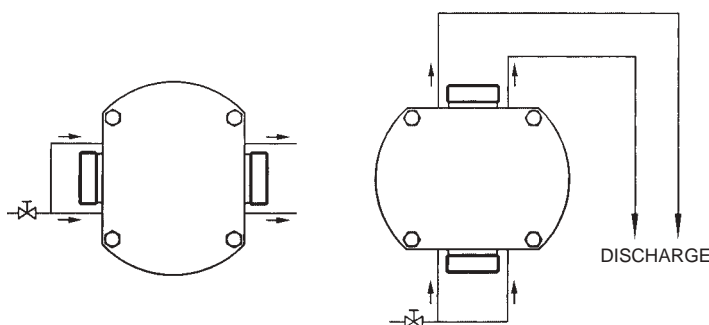

Flushing scheme for double mechanical seals with circuit under pressure

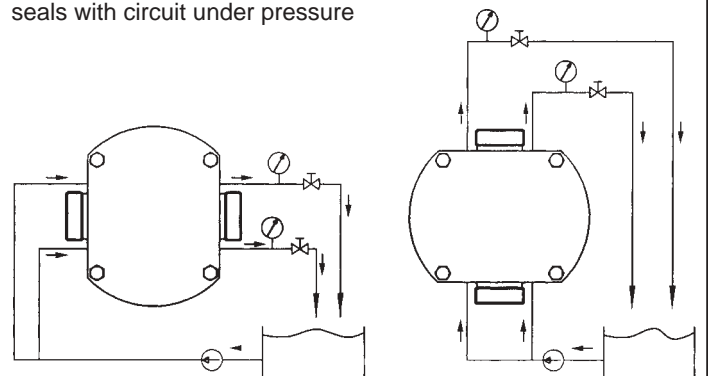

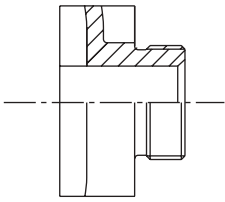

**CONNECTIONS WITH MALE GAS THREAD**

Treading with cylindric gas pitch, table UNI ISO 228-BSP

Code 0

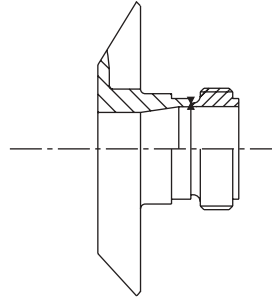

**CONNECTIONS WITH IDF ISS FITTING**

Sanitary fitting according BS 4825 ISS - IDF standard

Code 5

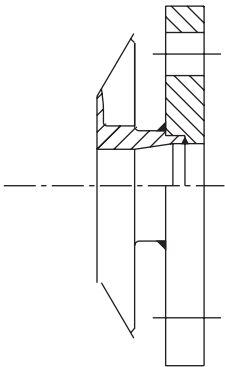

**CONNECTIONS WITH FLANGE**

Flange according to table UNI 2278/23 PN16 or other standards, upon demand

Code 1

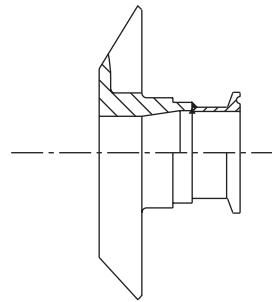

**CONNECTIONS WITH TRI-CLAMP FITTING**

Sanitary fitting according to American TRI-CLAMP standard

Code 6

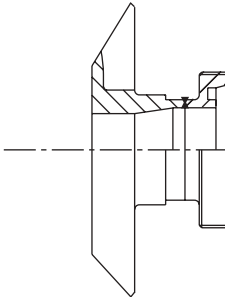

**CONNECTIONS WITH DIN FITTING**

Sanitary fitting according to DIN 11851 F. standard. DIN 405 threading

Code 2

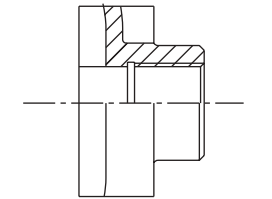

**CONNECTIONS WITH FEMALE GAS THREAD**

Treading with cylindric gas pitch, table UNI ISO 228-BSP

Code 7

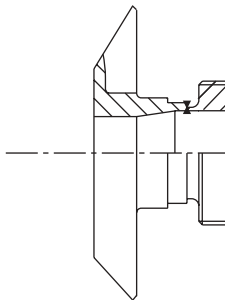

**CONNECTIONS WITH SMS FITTING**

Sanitary fitting according SMS 1145 with DIN 405 threading

Code 3

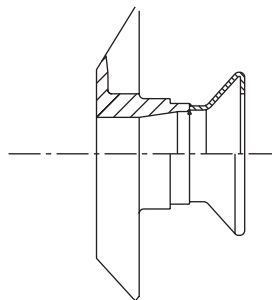

**CONNECTIONS WITH WINE FITTING**

Code 8

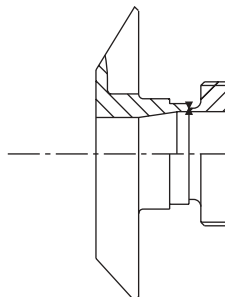

**CONNECTIONS WITH RJT FITTING**

Sanitary fitting according BS 18604 - RJT standard

Code 4



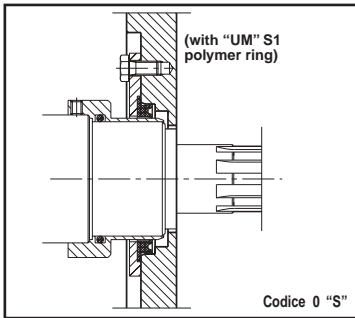

**LIP SEAL**

This is the simplest and cheapest type of seal, consisting of a Viton UM ring (for lubricating products, animal and vegetable oils, greases, cosmetic creams, etc) or S1 polymer (for chocolate). Both for low pressure and low speed applications.

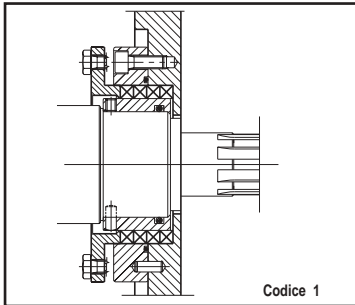
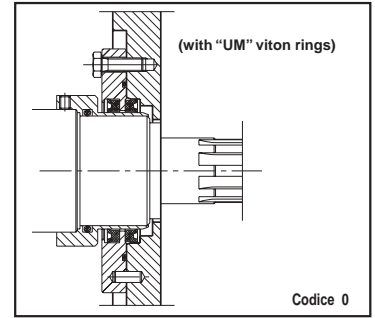

**PACKING GLAND**

This is the typical traditional system, consisting of a gland follower pushing on Teflon-treated braid rings which slide on a sleeve fixed to the rotating shaft. This type of seal is now rarely used since in order to function properly it must leak to ensure that the entire braid pack is lubricated by the product (to prevent overheating and guarantee good life). The gland follower must be tightened at regular intervals to compensate wear in the braid rings. This type of seal is still suitable for glueing products, flushing of mechanical seal is not admitted, such as: glues, resins, rubber cements, molasses, etc.

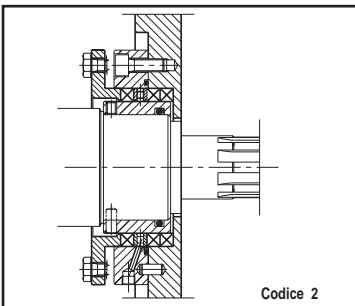

**FLUSHED PACKING GLAND**

This is a variant of the packing gland with the addition of an hydraulic ring for flushing of the liquid (usually water). This enables the braid packing to be kept wet and cool in order to prevent overheating when pumping hot products and also creates an hydraulic barrier between atmosphere and pumped product.

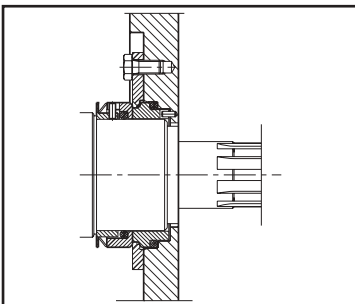

**BALANCED ROTARY MECHANICAL SEAL**

This is the most widely used kind of seal. Simple and hygienic, it requires no adjustment or maintenance apart from replacement due to wear. Depending on the type, the two mating faces can be in stainless steel/carbon (code 3) or:  
 tungsten carbide/carbon (code 4)  
 tungsten carbide/tung.carbide (code 5)  
 ceramic/carbon (code 6)  
 ceramic/rulon (code 7)  
 silicon carbide/sil. carbide (code 8)

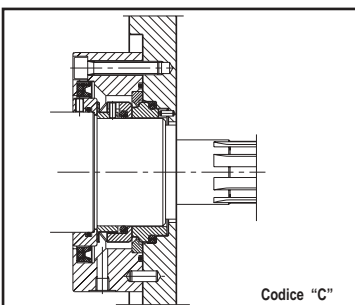

**FLUSHED BALANCED ROTARY MECHANICAL SEAL**

All the simple compact seals used can be flushed with the option of a flushing seal box with a radial UM or lip ring liquid seal. Water or some other non-polluting liquid flows at low pressure in the flushing seal box and washes the seal constantly so as to cool, lubricate if it is running dry, and prevent solid deposits from sugar syrups, tartrates etc. On the surfaces of the seal, as this would affect its working and life.

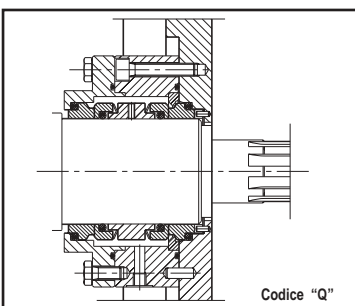

**FLUSHED DOUBLE BALANCED ROTARY MECHANICAL SEAL**

It is an application with the same principle of the flushed balanced rotary mechanical seal, with the difference in the sealing of the flushing liquid made by the mechanical seal. In this case the flushing liquid can circulate at an higher pressure then the one of the transferring liquid with which it must be compatible.

The bi-lobe and rotary piston rotors are used for pumping extremely delicate products, in particular, products containing solids in suspension.

These can be pumped with a minimum damage, as a result of the rotor shape that comes into contact only twice per revolution.

Hereinafter some pumped products: fruit jams, fruit salads, diced fruit in syrup, mustard, curd, soft cheese, yoghurt with fruit, tomato purée and diced tomato, vegetable sauces, vegetable-soup, mushroom, confectionery products containing solids in suspension (chocolate, hazel-nut and almond chips etc...).

Maximum allowable solids dimensions for pump models:

B110-B115	max	mm	10
B215-B220	max	mm	12
B325-B330	max	mm	15
B430-B440	max	mm	19
B470-B490	max	mm	22
B550	max	mm	25
B660-B680	max	mm	30

Dual wing rotary piston



Code 5

Bi-lobe rotors with conjugate profile



Code 2 - 3 - 6

For the suction and discharge pipes it is advisable a diameter which is minimum 4 times the size of the pieces contained in the product.

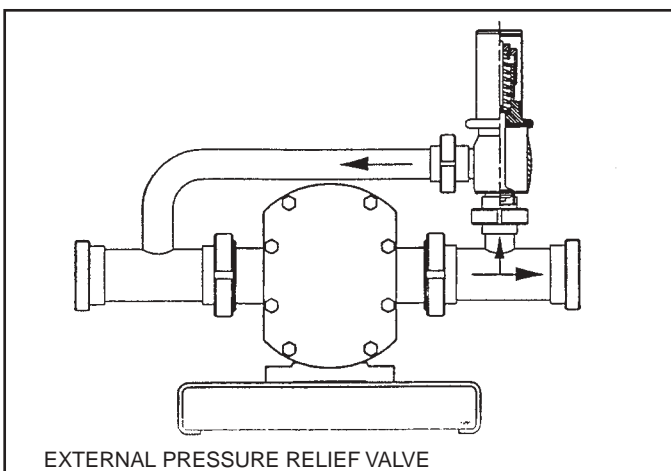
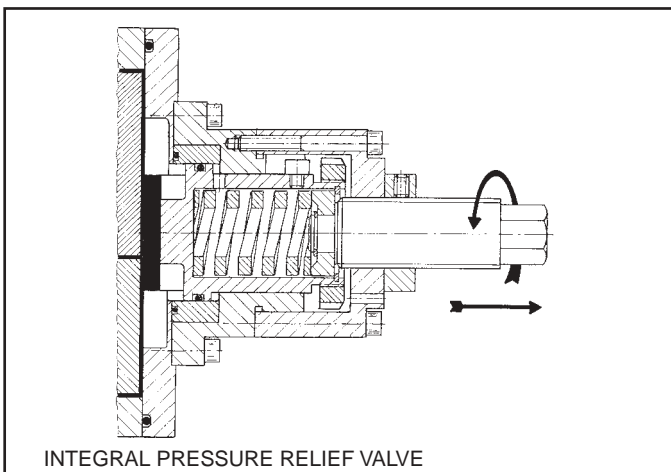

The pumps can be supplied on request with hygienic by-pass or pressure relief valves. This device protects the pump from pressure peaks or restrictions in the discharge and assures excess liquid deviation during CIP and SIP. The relief valve can be manually selected as a flow regulator in order to pass product allowing the pump to run continuously. This valve can be incorporated in the end cover that replaces the standard cover (Fig. 1), providing a pressure relief valve loop from discharge to the suction area; alternatively it can be incorporated in the discharge pipework (Fig. 2), relieving excess pressure by by-passing product through a loop back to the suction side. The integral relief valve is suitable for CIP process line and functions for either direction of flow: it is available on Models B105 to B440. On all models it is possible to assemble an external pressure relief valve in order to recycle the whole pumped product, this valve is especially suitable for frequently operations and for volatile, heat or shear sensitive product. For both of the valves a manual, pneumatic or automatic operation is available.

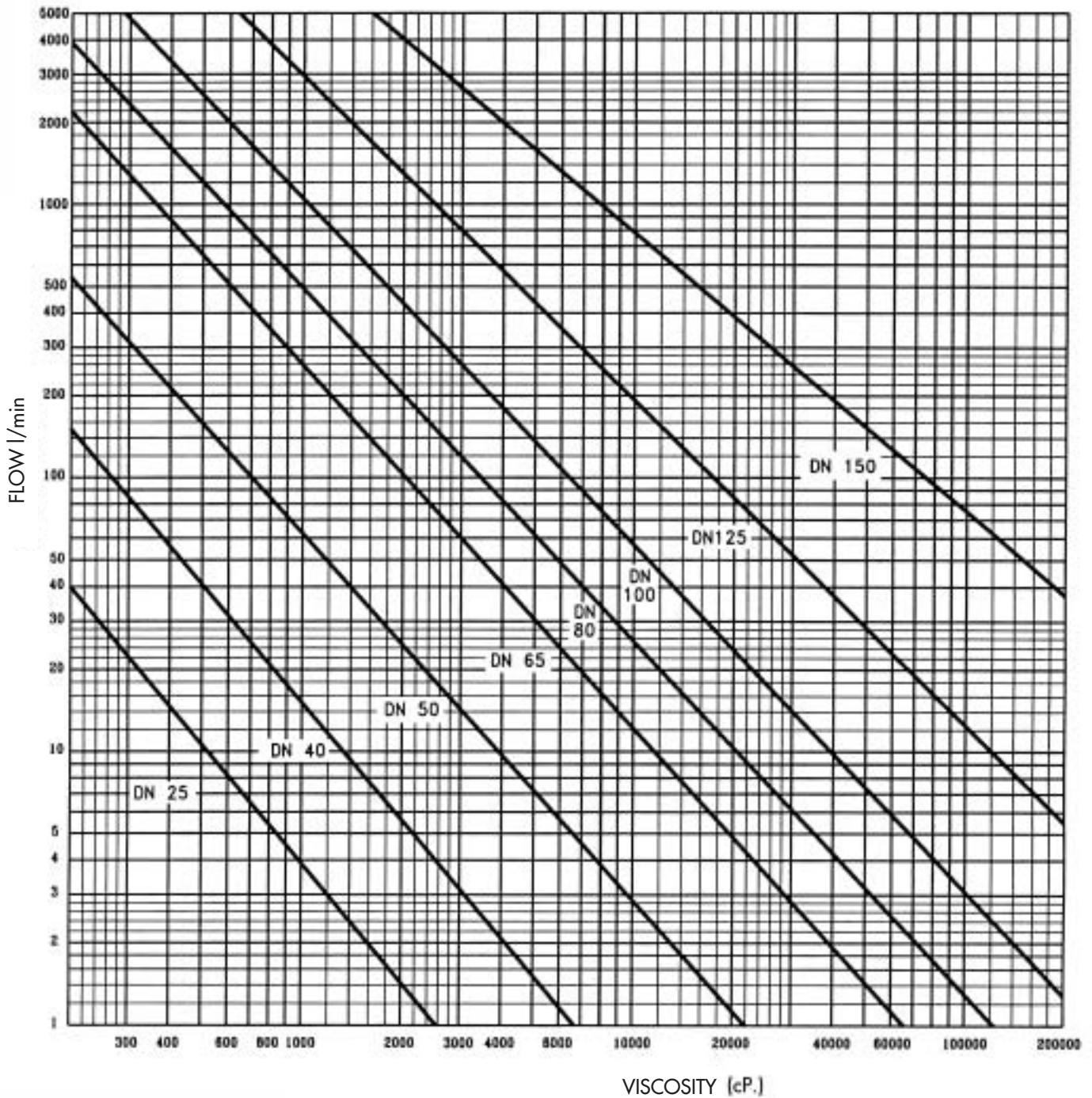

- Piping DN 25 = Ø et 28 x 1,5 thickness  
 “ DN 40 = Ø et 40 x 1,5 “  
 “ DN 50 = Ø et 52 x 1,5 “  
 “ DN 65 = Ø et 70 x 2 “  
 “ DN 80 = Ø et 85 x 2 “  
 “ DN 100 = Ø et 102 x 2 “  
 “ DN 125 = Ø et 129 x 2 “  
 “ DN 150 = Ø et 168 x 3 “

For products having viscosity above 500 cPs in order to reduce suction head losses the suction pipe size must be equivalent to the pump port, even if the chart is selecting a smaller size.

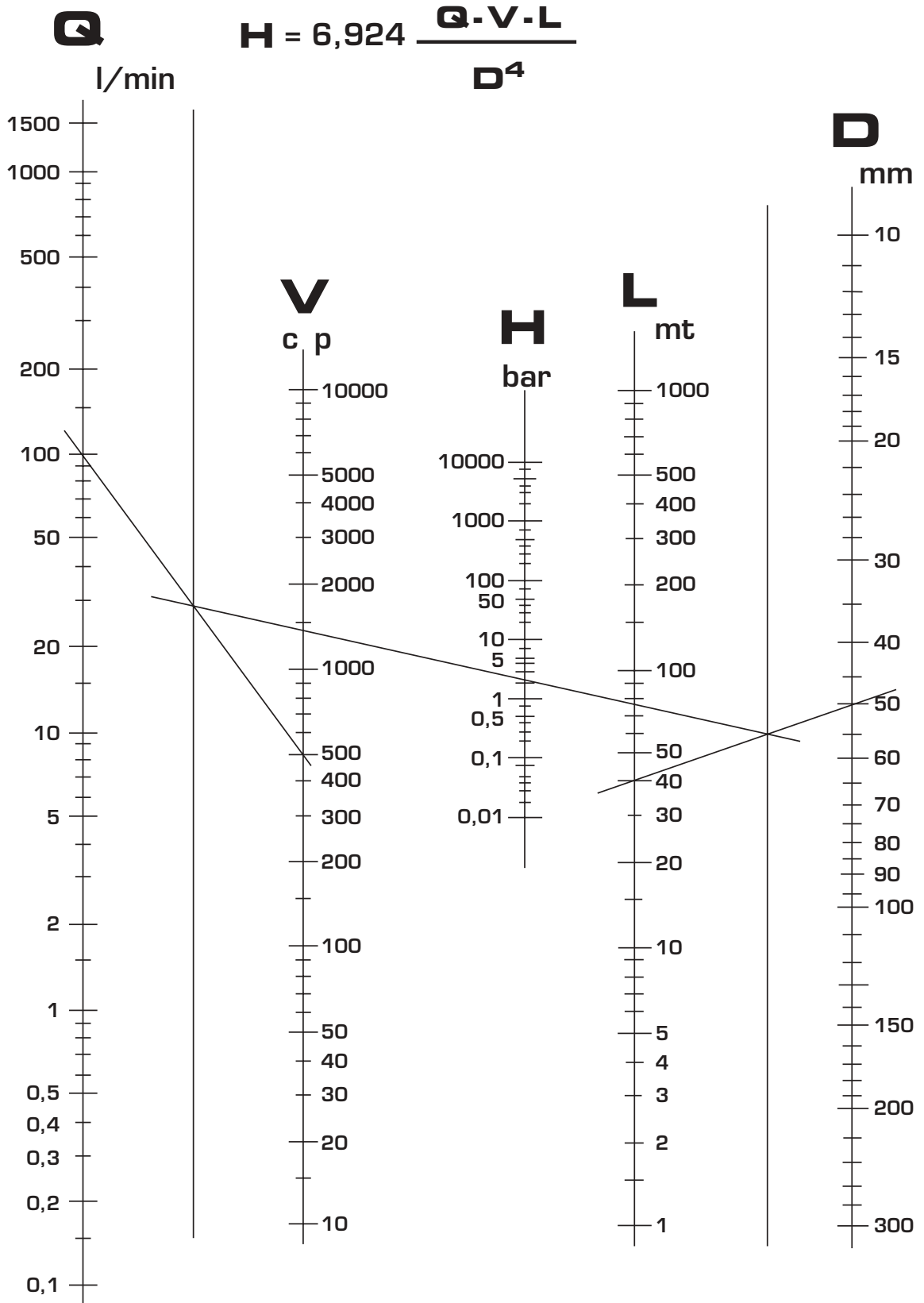

Example: Flow	Q = 100 lt/min	Result:
Viscosity	V = 500 mPa (cP.)	H = 2 bar
Pipe length	L = 40 m	head loss
Pipe diameter	d = 50 mm	

Each fitting has a reference number corresponding to the chart lines

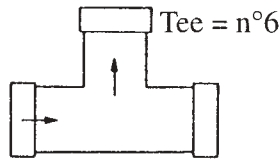
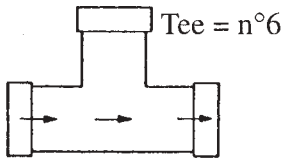

Angle valve  
Open = No. 4

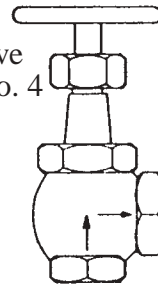

Globe valve  
Open = No. 2

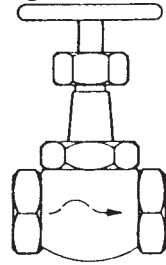

Pipe bore (inches)

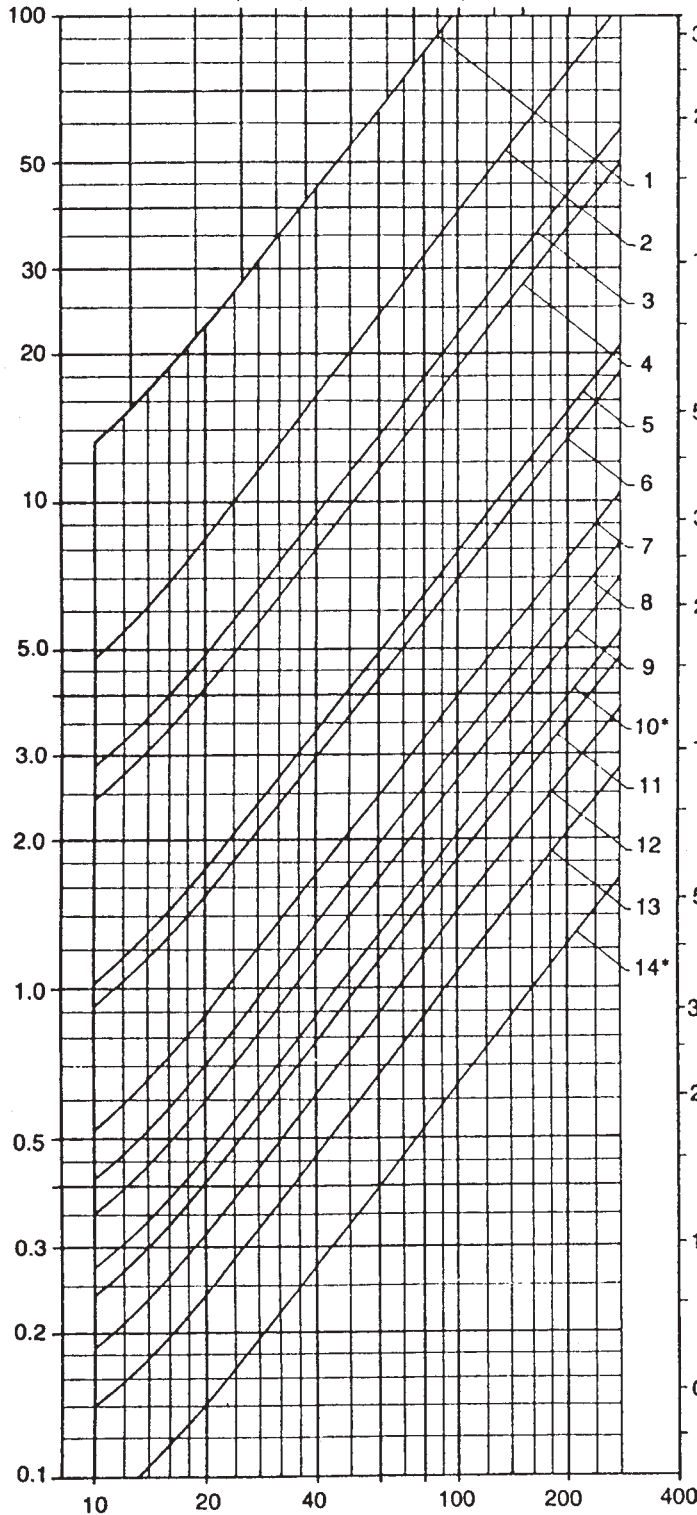

Pipe run - metres

Pipe run - feet

Pipe bore (mm)

Gate valve  
Closed 25% = n° 7  
Closed 50% = n° 3  
Closed 75% = n° 1  
Open = n° 14

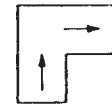
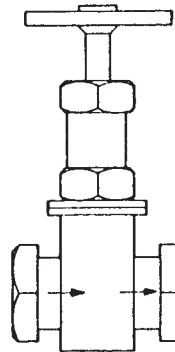

Square elbow = n°6

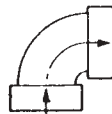
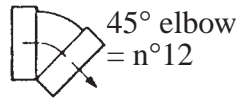

Standard elbow = n°18

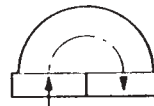

180° elbow = n°5

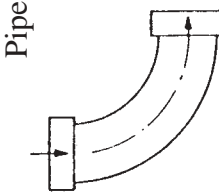

Long sweep elbow = n°10

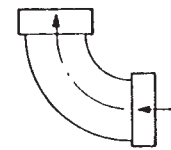

Medium sweep elbow = n°9

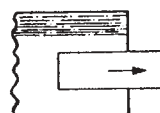

Reduction = n°8

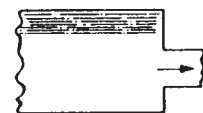

Reduction = n°11

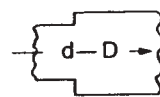

Sudden enlargement  
d / D = 0,25 n°8  
d / D = 0,50 n°11  
d / D = 0,75 n°14

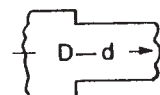

Sudden contraction  
d / D = 0,25 n°12  
d / D = 0,50 n°13  
d / D = 0,75 n°14

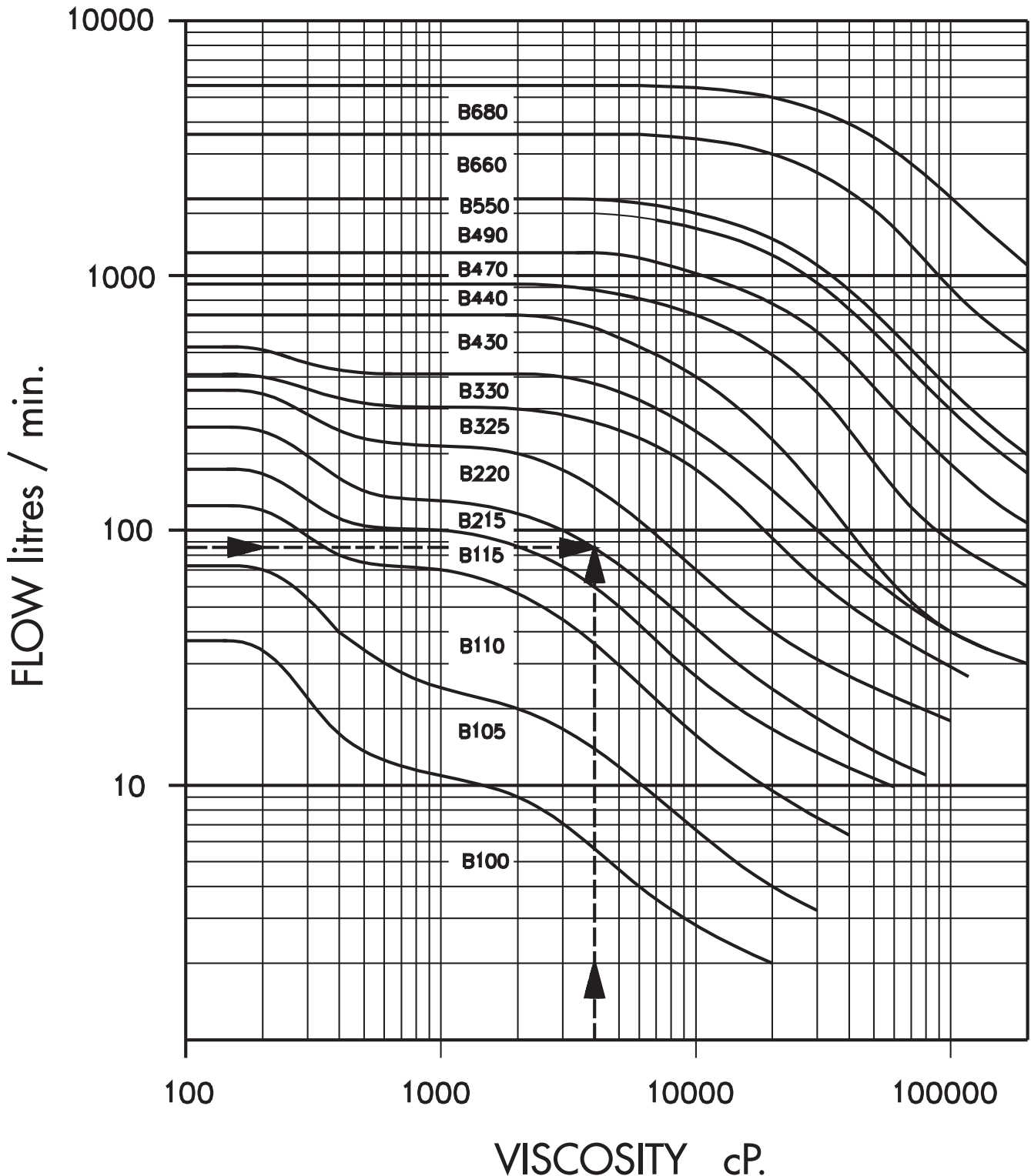

The curves on this chart define the fields of operation of the various sizes of pump, enabling a preliminary selection to be made according to viscosity/flow. For example: viscosity = 4000 cP, Flow = 85 lt/min, the appropriate pump is the model B 220.

This preliminary selection should subsequently be checked on the pump installation layout, taking into consideration: nature of the liquid to be pumped, NPSH available, suction distance, vapour pressure and discharge head losses.

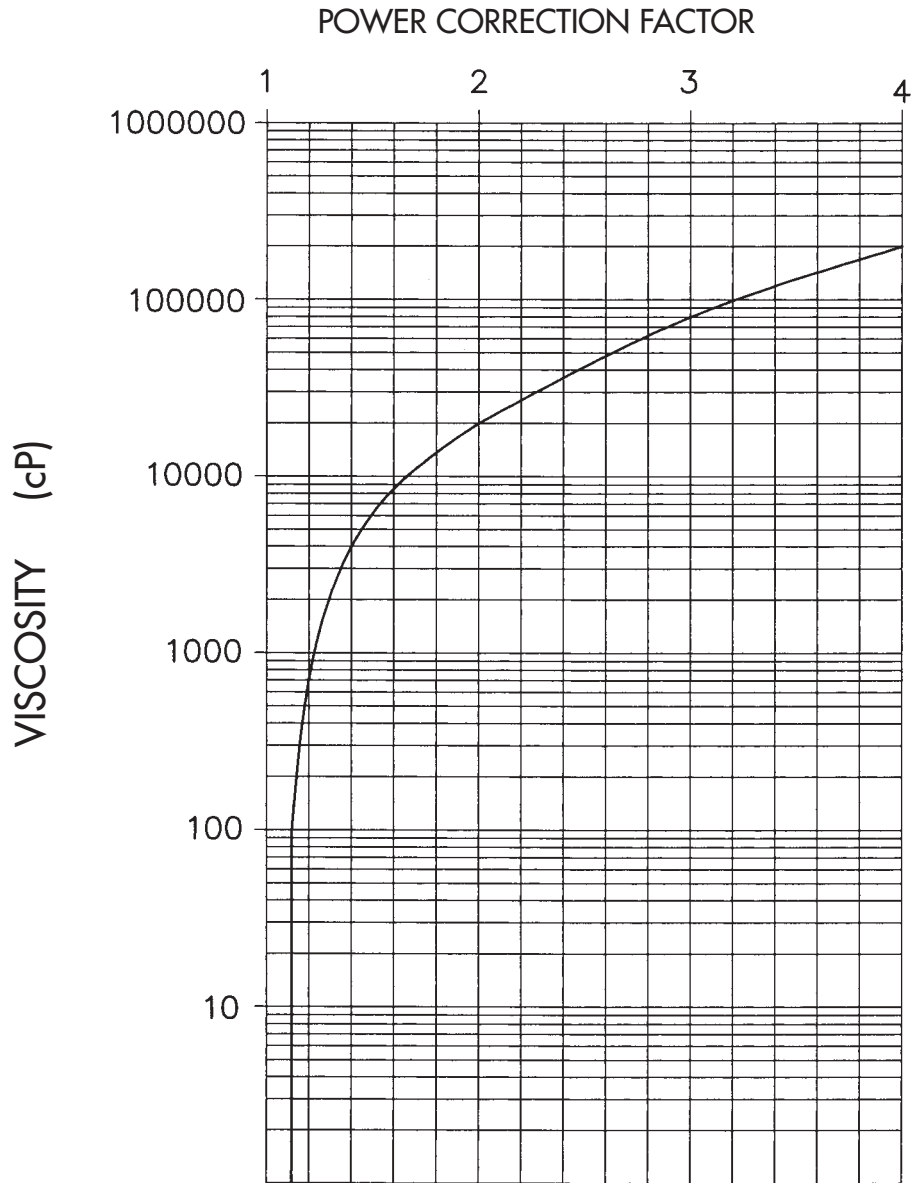

The power calculated from the following performance charts as a function of hydraulic data must be corrected multiplying it by the "Power correction factor". According to the viscosity.

The following data are needed to be able to make an optimum choice of pump:

- PRODUCT : characteristics
- FLOW : litres/min.
- PRESSURE : bar
- VISCOSITY : cP
- TEMPERATURE : °C

- 1) From page 14 choose the appropriate model of pump according to the flow and viscosity.  
For viscosities from 1 to 100 cP the selected speed of rotation should not exceed the maximum allowed pump speed (see performance charts)  
**IMPORTANT:** In any case check if the speed of rotation obtained from the charts could affect the product features.
- 2) From the performance charts of the selected size of pump, read off the speed of rotation and the hydraulic power according to the instructions given on page 17.
- 3) Multiply the value of the hydraulic power by the power correction factor (points 8-9 on page 17).
- 4) The value of the hydraulic power obtained can be calculated with the following formula:

$$Na = \frac{Q \times n \times H \times Fp}{600 \times r} = \text{kW}$$

- Na = absorbed power in kW
- Q = volumetric flow l/rev.
- n = speed of rotation r.p.m.
- H = pressure in bar
- Fp = power correction factor, page 15
- r = average efficiency 0.75

5) Checking the TORQUE in Nm.

$$Nm = \frac{Na \times 9555}{n} = \frac{Kw \times 9555}{r.p.m.}$$

MAX. TORQUES - Nm	
B 100	50
B105 - B110	105
B115	183
B215 - B220	210
B325 - B330	467
B430 - B440	993
B470 - B490 - B550	1420
B660 - B680	4160

In the most heavy duties it is necessary to check that the calculated torque does not exceed the maximum allowed torque for each individual size of pump.

**PRACTICAL PROCEDURE FOR PUMP SELECTION**

- 1) Data: Product : cream  
Flow : 3000 litres/hour = 50 litres/min.  
Pressure : 4 bar  
Viscosity : 20 cP.

In view of the delicate nature of the product, it is recommended that the speed of rotation be kept down to 400 r.p.m.

From the performance chart of the pump size B 220 (page 18), a pressure of 4 bar and a viscosity of 20 cP give a flow of 50 litres/min. at the speed of 350 r.p.m. with an hydraulic power of 1.2 kW. The theoretical value obtained for hydraulic power must be multiplied by the power correction factor (pag. 15) in order to obtain the real absorbed power value.

$$Na = 1.2 \times 1.1 = 1.32 \text{ Kw absorbed power}$$

- 2) Data: Product : sugary syrup  
Flow : 5000 litres/hour = 83.3 litres/min.  
Pressure : 4 bar  
Viscosity : 4000 cP.

From page 14, pump mod. B 220 is chosen for a flow of 83.3 litres/min and viscosity 4,000 cP. From the performance chart of the pump size B 220 (page 19), a pressure of 4 bar and a viscosity of 4,000 cP correspond to a flow of 83.3 litres/min at a speed of 240 r.p.m. with an hydraulic power of 0,75 kW. The value obtained for hydraulic power must be multiplied by the correction factor (pag. 15) in order to obtain in the real absorbed power.

$$Na = 0.75 \times 1.4 = 1.05 \text{ kW}$$



Q = Flow l/min

Viscosity cPs

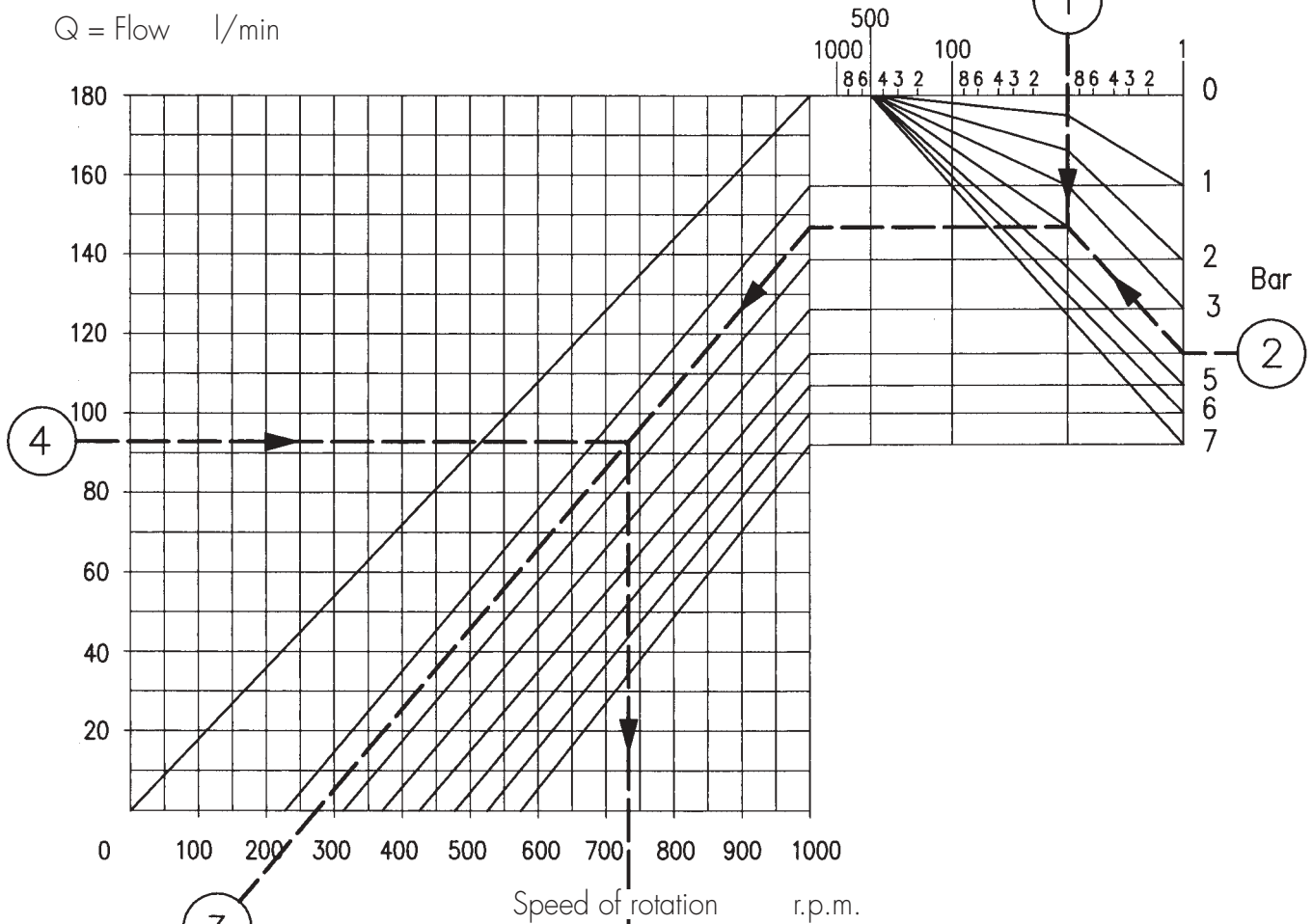

Kw = Absorbed power

Power correction factor cP.

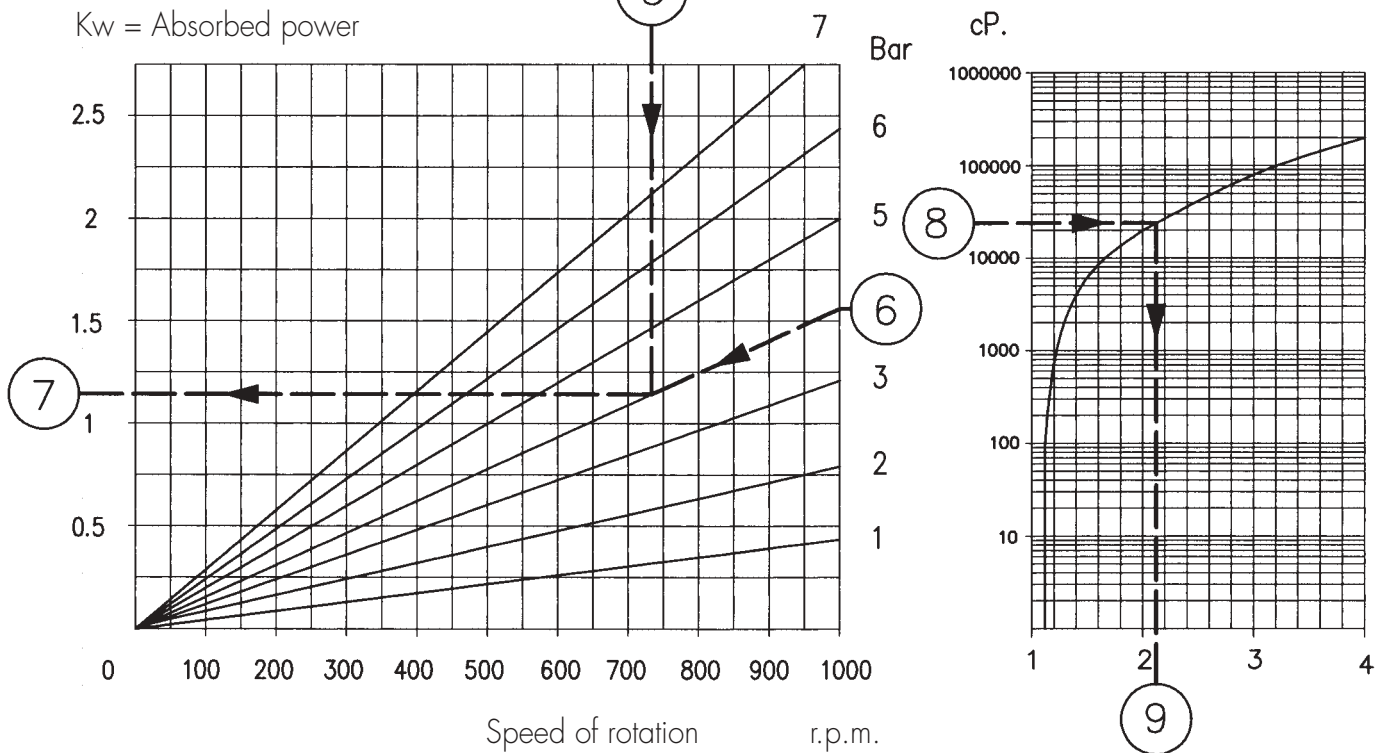

Q = Flow l/min

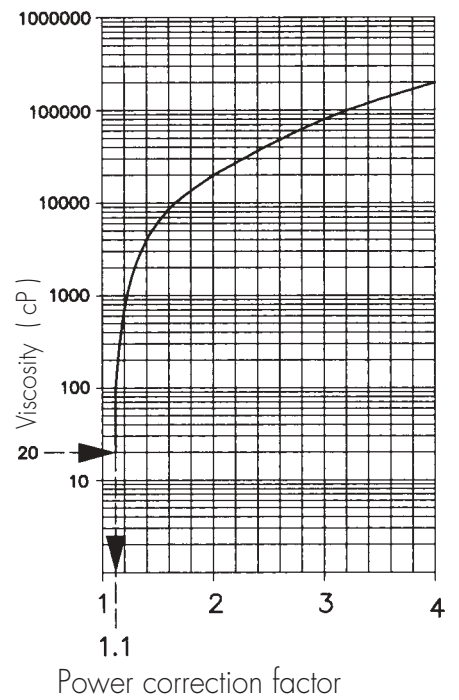
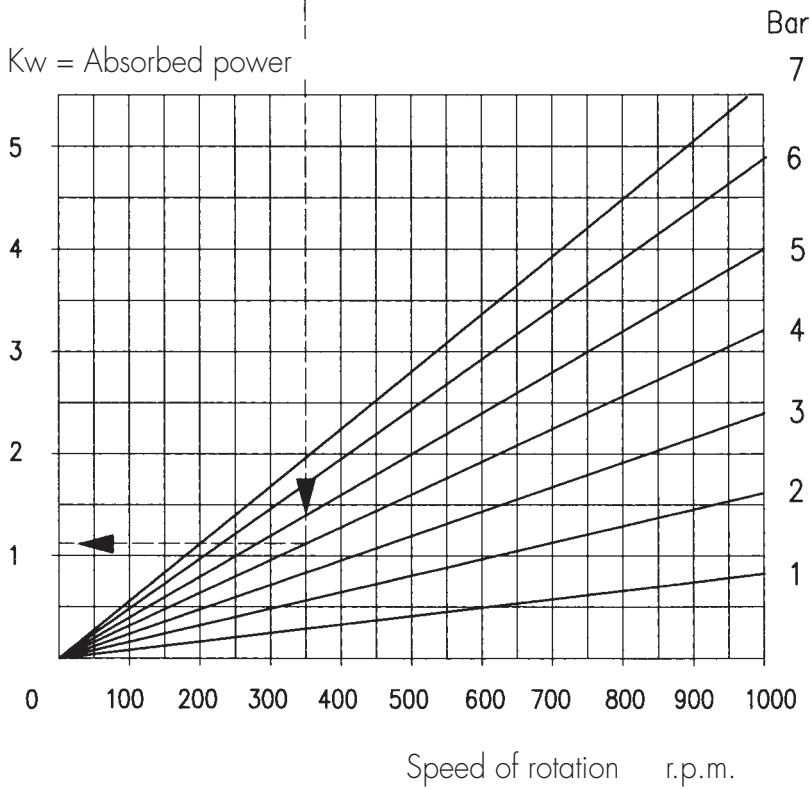
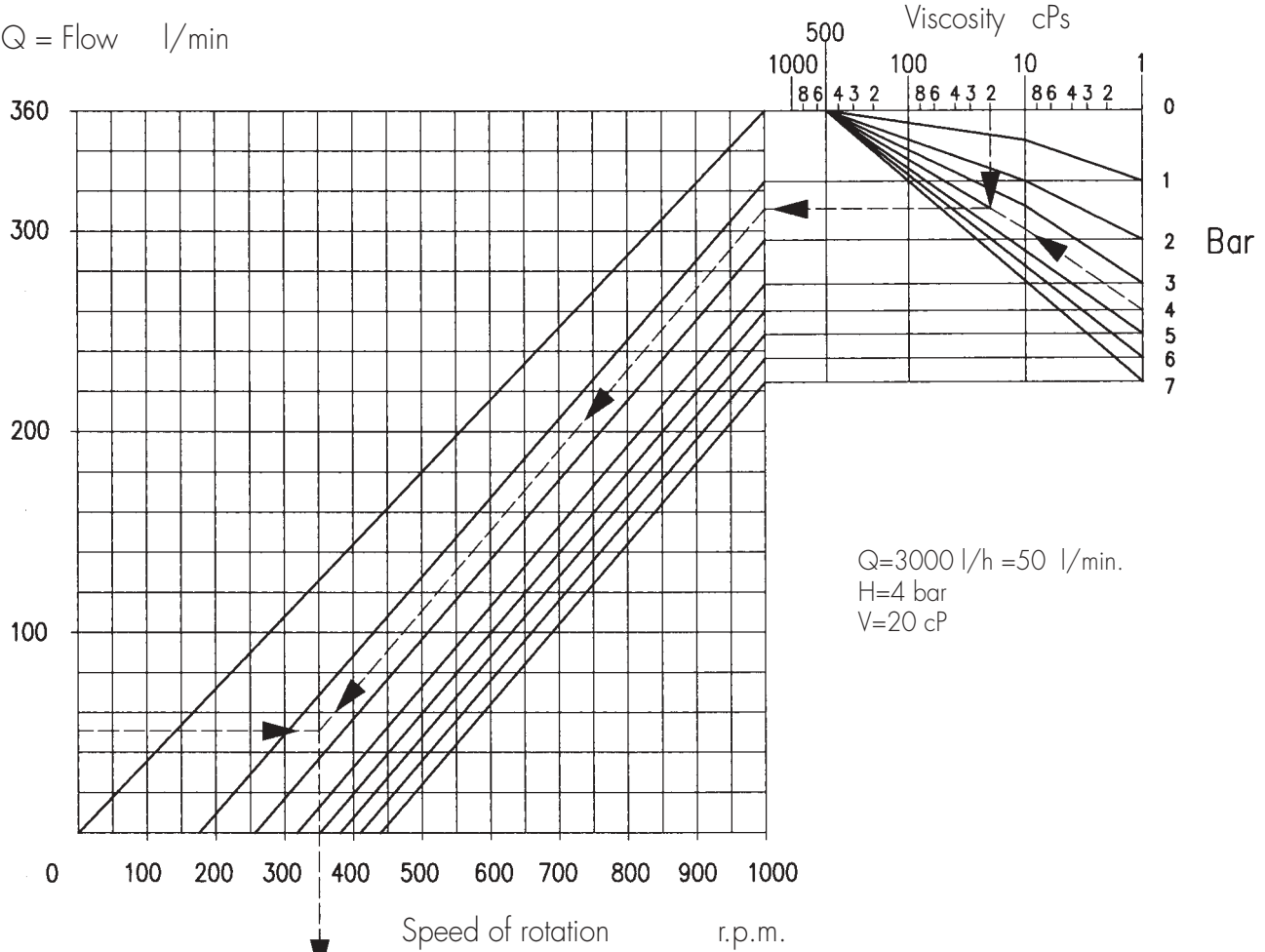

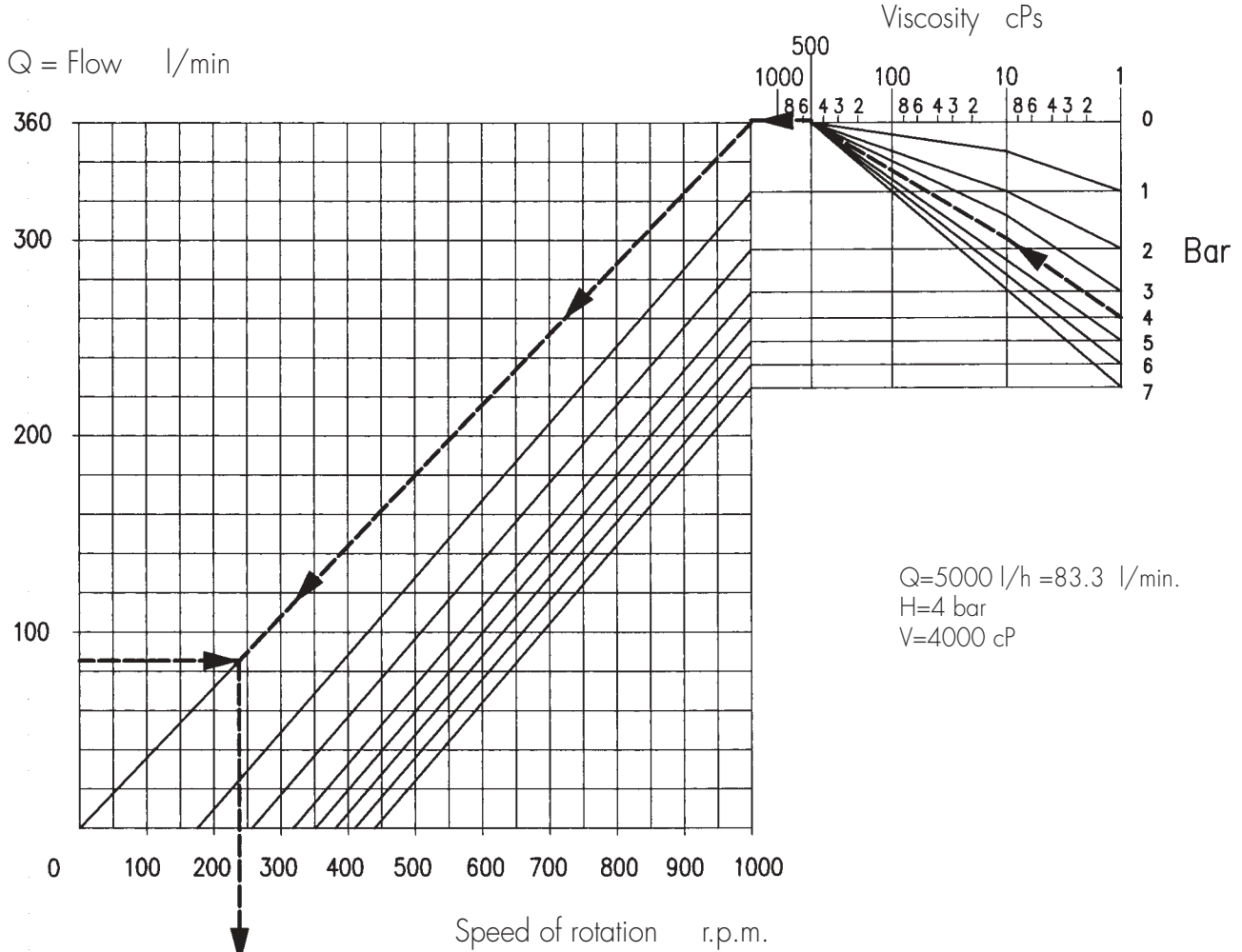

Q=5000 l/h = 83.3 l/min.  
 H=4 bar  
 V=4000 cP

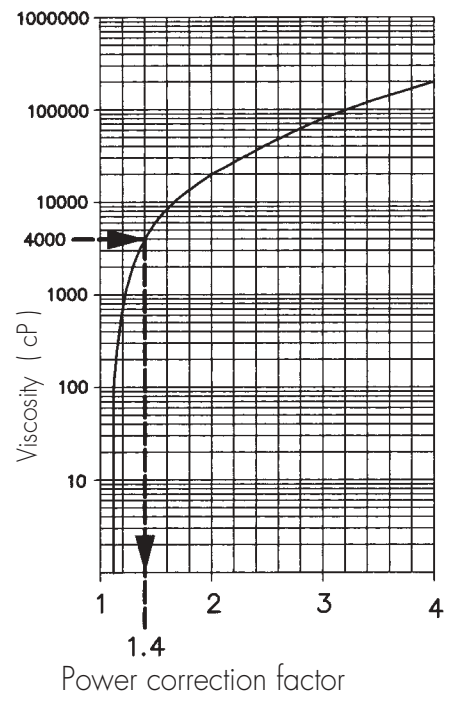
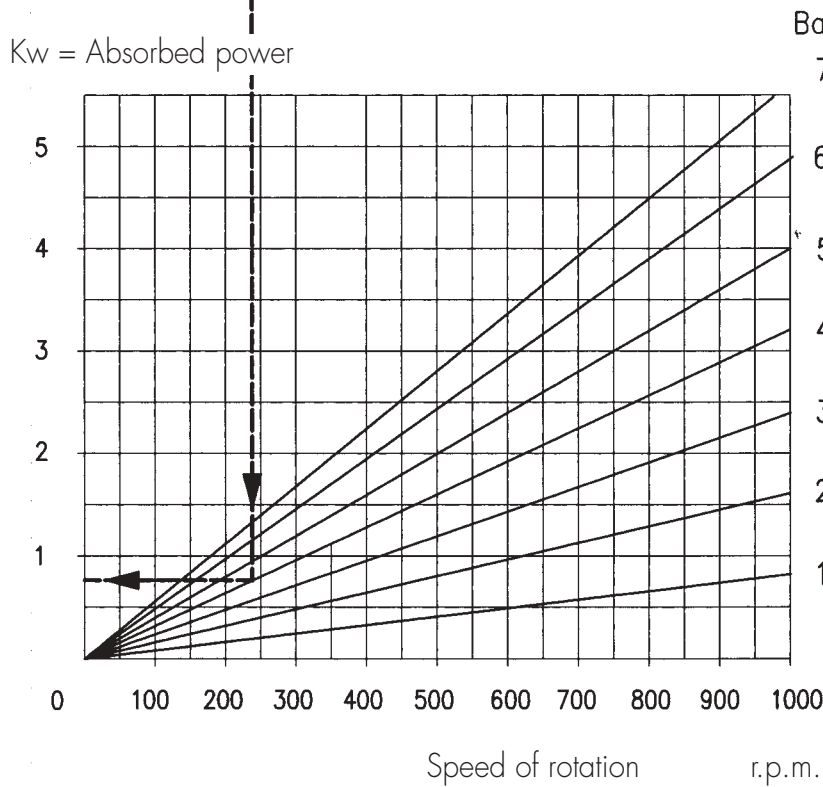

t°C = temperature in degrees centigrade

K = temperature in Kelvin

Ps = vapour pressure

γ = specific weight

t °C	T K	Ps bar	γ kg/dm <sup>3</sup>	t °C	T K	Ps bar	γ kg/dm <sup>3</sup>	t °C	T K	Ps bar	γ kg/dm <sup>3</sup>
0	273,15	0,00611	0,9998					138	411,15	3,414	0,9276
1	274,15	0,00657	0,9999	61	334,15	0,2086	0,9826	140	413,15	3,614	0,9258
2	275,15	0,00706	0,9999	62	335,15	0,2184	0,9821	145	418,15	4,155	0,9214
3	276,15	0,00758	0,9999	63	336,15	0,2286	0,9816	150	423,15	4,760	0,9168
4	277,15	0,00813	1,0000	64	337,15	0,2391	0,9811	155	428,15	5,433	0,9121
5	278,15	0,00872	1,0000	65	338,15	0,2501	0,9805	160	433,15	6,181	0,9073
6	279,15	0,00935	1,0000	66	339,15	0,2615	0,9799	165	438,15	7,008	0,9024
7	280,15	0,01001	0,9999	67	340,15	0,2733	0,9793	170	433,15	7,920	0,8973
8	281,15	0,01072	0,9999	68	341,15	0,2856	0,9788	175	448,15	8,924	0,8921
9	282,15	0,01147	0,9998	69	342,15	0,2984	0,9782	180	453,15	10,027	0,8869
10	283,15	0,01227	0,9997	70	343,15	0,3116	0,9777	185	458,15	11,233	0,8815
11	284,15	0,01312	0,9997	71	344,15	0,3253	0,9770	190	463,15	12,551	0,8760
12	285,15	0,01401	0,9996	72	345,15	0,3396	0,9765	195	468,15	13,987	0,8704
13	286,15	0,01497	0,9994	73	346,15	0,3543	0,9760	200	473,15	15,55	0,8647
14	287,15	0,01597	0,9993	74	347,15	0,3696	0,9753	205	478,15	17,243	0,8588
15	288,15	0,01704	0,9992	75	348,15	0,3855	0,9748	210	483,15	19,077	0,8528
16	289,15	0,01817	0,9990	76	349,15	0,4019	0,9741	215	488,15	21,060	0,8467
17	290,15	0,01936	0,9988	77	350,15	0,4189	0,9735	220	493,15	23,198	0,8403
18	291,15	0,02062	0,9987	78	351,15	0,4365	0,9729	225	498,15	25,501	0,8339
19	292,15	0,02196	0,9985	79	352,15	0,4547	0,9723	230	503,15	27,976	0,8273
20	293,15	0,02337	0,9983	80	353,15	0,4736	0,9716	235	508,15	30,632	0,8205
21	294,15	0,02485	0,9981	81	354,15	0,4931	0,9710	240	513,15	33,478	0,8136
22	295,15	0,02642	0,9978	82	355,15	0,5133	0,9704	245	518,15	36,523	0,8065
23	296,15	0,02808	0,9976	83	356,15	0,5342	0,9697	250	523,15	39,776	0,7992
24	297,15	0,02982	0,9974	84	357,15	0,5557	0,9691	255	528,15	43,246	0,7916
25	298,15	0,03166	0,9971	85	358,15	0,5780	0,9684	260	533,15	46,943	0,7839
26	299,15	0,03360	0,9968	86	359,15	0,6011	0,9678	265	538,15	50,877	0,7759
27	300,15	0,03564	0,9966	87	360,15	0,6249	0,9671	270	543,15	55,058	0,7678
28	301,15	0,03778	0,9963	88	361,15	0,6495	0,9665	275	548,15	59,496	0,7593
29	302,15	0,04004	0,9960	89	362,15	0,6749	0,9658	280	553,15	64,202	0,7505
30	303,15	0,04241	0,9957	90	363,15	0,7011	0,9652	285	558,15	69,186	0,7415
31	304,15	0,04491	0,9954	91	364,15	0,7281	0,9644	290	563,15	74,461	0,7321
32	305,15	0,04753	0,9951	92	365,15	0,7561	0,9638	295	568,15	80,037	0,7223
33	306,15	0,05029	0,9947	93	366,15	0,7849	0,9630	300	573,15	85,927	0,7122
34	307,15	0,05318	0,9944	94	367,15	0,8146	0,9624	305	578,15	92,144	0,7017
35	308,15	0,05622	0,9940	95	368,15	0,8453	0,9616	310	583,15	98,700	0,6906
36	309,15	0,05940	0,9937	96	369,15	0,8769	0,9610	315	588,15	105,61	0,6791
37	310,15	0,06274	0,9933	97	370,15	0,9094	0,9602	320	593,15	112,89	0,6669
38	311,15	0,06624	0,9930	98	371,15	0,9430	0,9596	325	598,15	120,56	0,6541
39	312,15	0,06991	0,9927	99	372,15	0,9776	0,9586	330	603,15	128,63	0,6404
40	313,15	0,07375	0,9923	100	373,15	1,0133	0,9581	340	613,15	146,05	0,6102
41	314,15	0,07777	0,9919	102	375,15	1,0878	0,9567	350	623,15	165,35	0,5743
42	315,15	0,08198	0,9915	104	377,15	1,1668	0,9552	360	633,15	186,75	0,5275
43	316,15	0,08639	0,9911	106	379,15	1,2504	0,9537	370	643,15	210,54	0,4518
44	317,15	0,09100	0,9907	108	381,15	1,3390	0,9522	374,15	647,30	221,2	0,3154
45	318,15	0,09582	0,9902	110	383,15	1,4327	0,9507				
46	319,15	0,10086	0,9898	112	385,15	1,5316	0,9491				
47	320,15	0,10612	0,9894	114	387,15	1,6362	0,9476				
48	321,15	0,11162	0,9889	116	389,15	1,7465	0,9460				
49	322,15	0,11736	0,9884	118	391,15	1,8628	0,9445				
50	323,15	0,12335	0,9880	120	393,15	1,9854	0,9429				
51	324,15	0,12961	0,9876								
52	325,15	0,13613	0,9871	122	395,15	2,1145	0,9412				
53	326,15	0,14293	0,9866	124	397,15	2,2504	0,9396				
54	327,15	0,15002	0,9862	126	399,15	2,3933	0,9379				
55	328,15	0,15741	0,9857	128	401,15	2,5435	0,9362				
56	329,15	0,16511	0,9852	130	403,15	2,7013	0,9346				
57	330,15	0,17313	0,9846								
58	331,15	0,18147	0,9842	132	405,15	2,8670	0,9328				
59	332,15	0,19016	0,9837	134	407,15	3,041	0,9311				
60	333,15	0,19920	0,9832	136	409,15	3,223	0,9294				

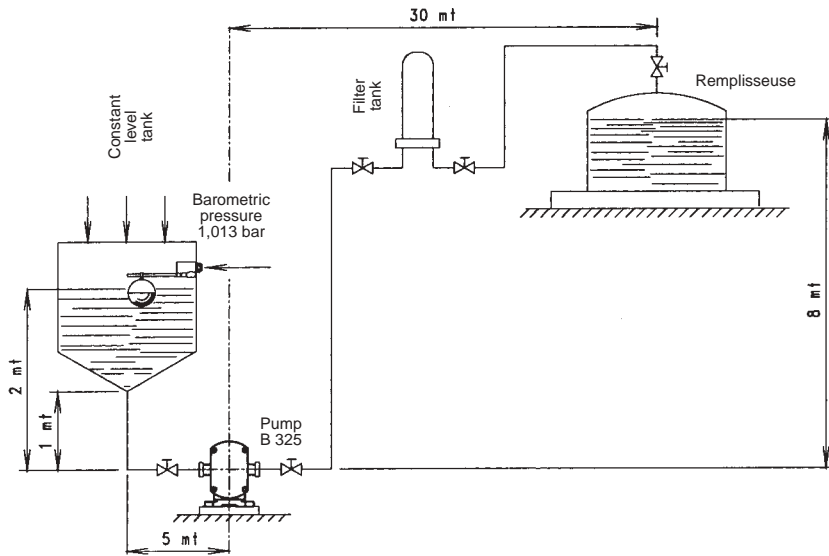

**BOTTLING PLANT**

Flow Q = 250 lit/min.  
 Viscosity = 300 cP.  
 Discharge head = 4 Bar  
 Piping = DN 65  
 Pump = B 325  
 Syrup  
 Temperature 30°C  
 Speed = 475 r.p.m.

**HEAD LOSSES ON PUMP SUCTION LINE**

Straight piping .....	mt 1+5 = 6
1 elbow (see page 13 no. 9 for pipe diam. 70) m equivalent pipe run .....	= 2
1 gate valve (see page 13 no. 13 for pipe diam. 70) m equivalent pipe run .....	= 1
<hr/>	
TOTAL = 9 m pipe run	

From diagram on page 12 for pipe diam. 70 - 9 m pipe run - viscosity 300 cP - flow 250 l/min., the loss in head is H = 0.15 bar.

**CALCULATION OF NPSH AVAILABLE**

Absolute atmospheric pressure .....	= 1,013	Bar +
Geodetic height .....	= 0,2	Bar +
Suction pipe head losses .....	= 0,15	Bar -
Vapour pressure at 30° C (page 20) .....	= 0,04241	Bar -
<hr/>		
NPSH available = 1,02059 Bar.		

**NPSH REQUIRED BY PUMP SIZE B 325**

- From page 49 for 250 l/min. - viscosity 300 cP - speed 475 r.p.m., the NPSH required is 0.82 bar.
- This NPSH is lower than the 1.02059 bar available so the choice of pumps is correct.

Otherwise, proceed as follows to raise the NPSH available:

- 1) increase the head on the pump (geodetic height)
- 2) increase the pipe bore in order to reduce frictional head losses
- 3) if operations 1 and 2 are not sufficient, choose a larger pump in order to work at lower speed.

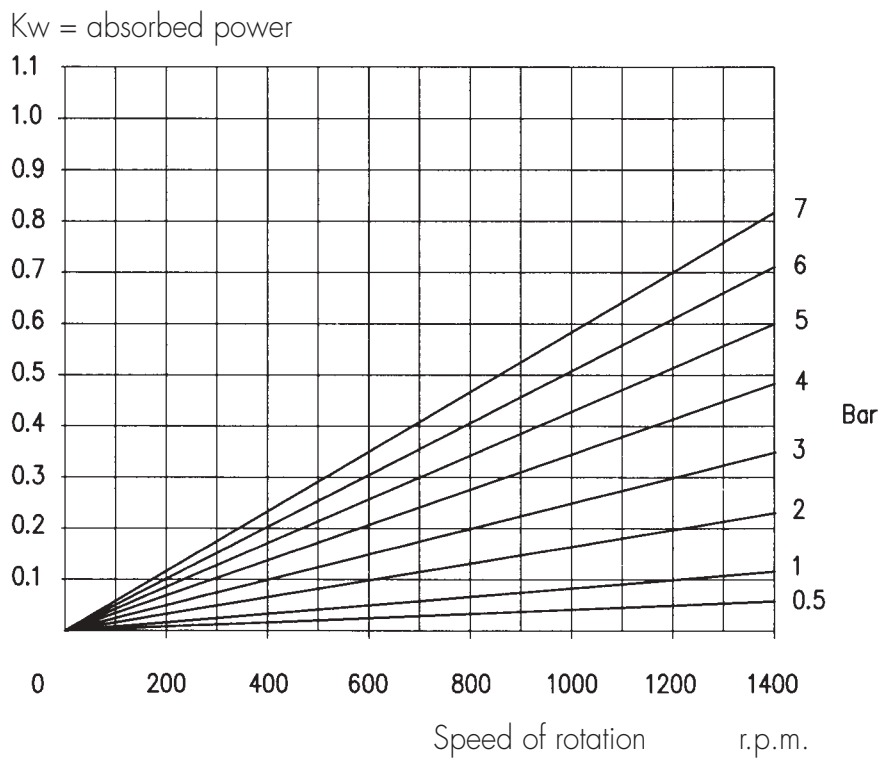
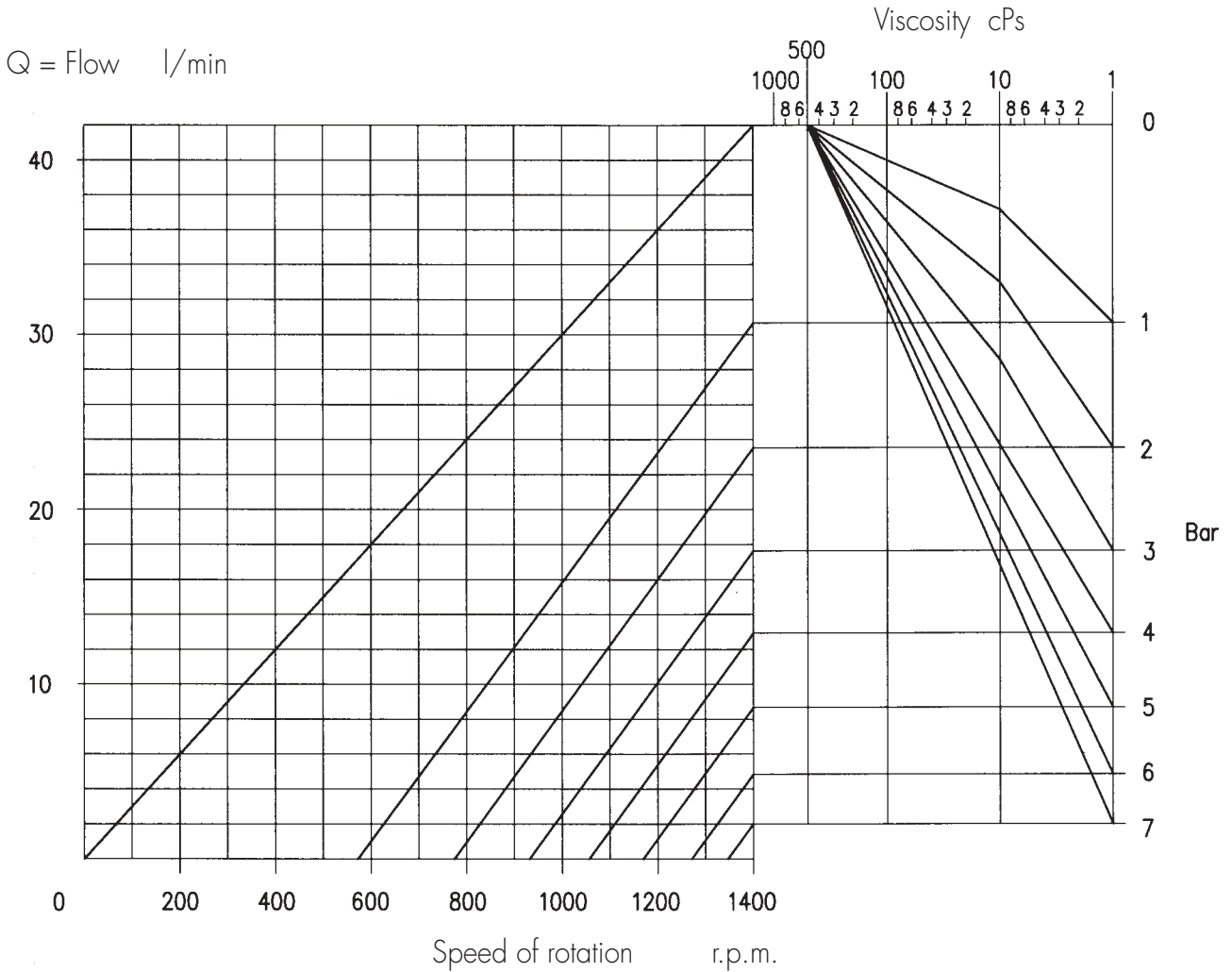

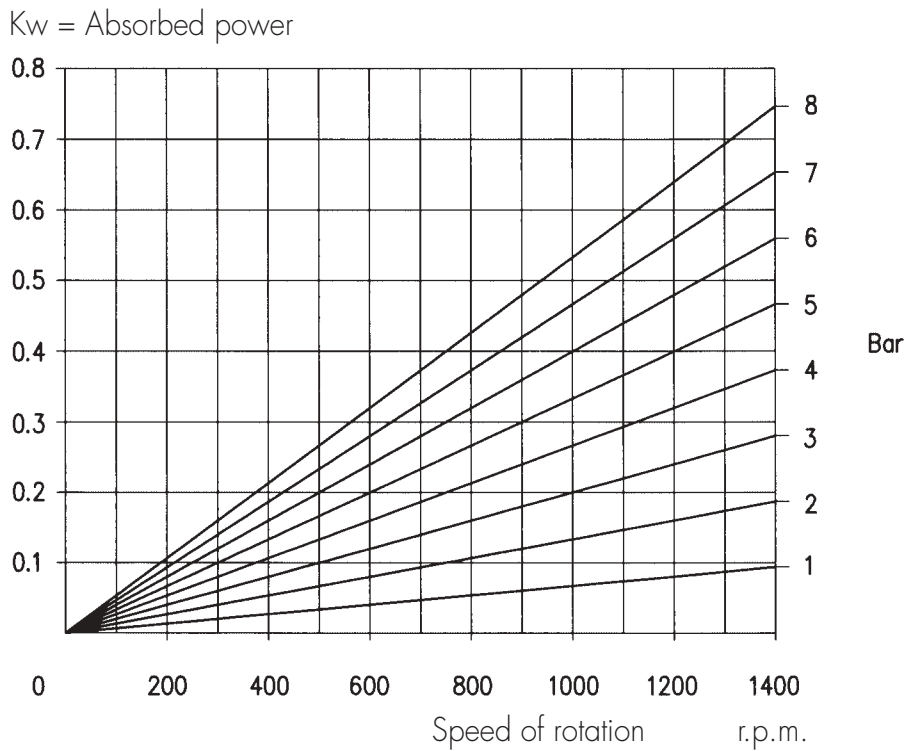
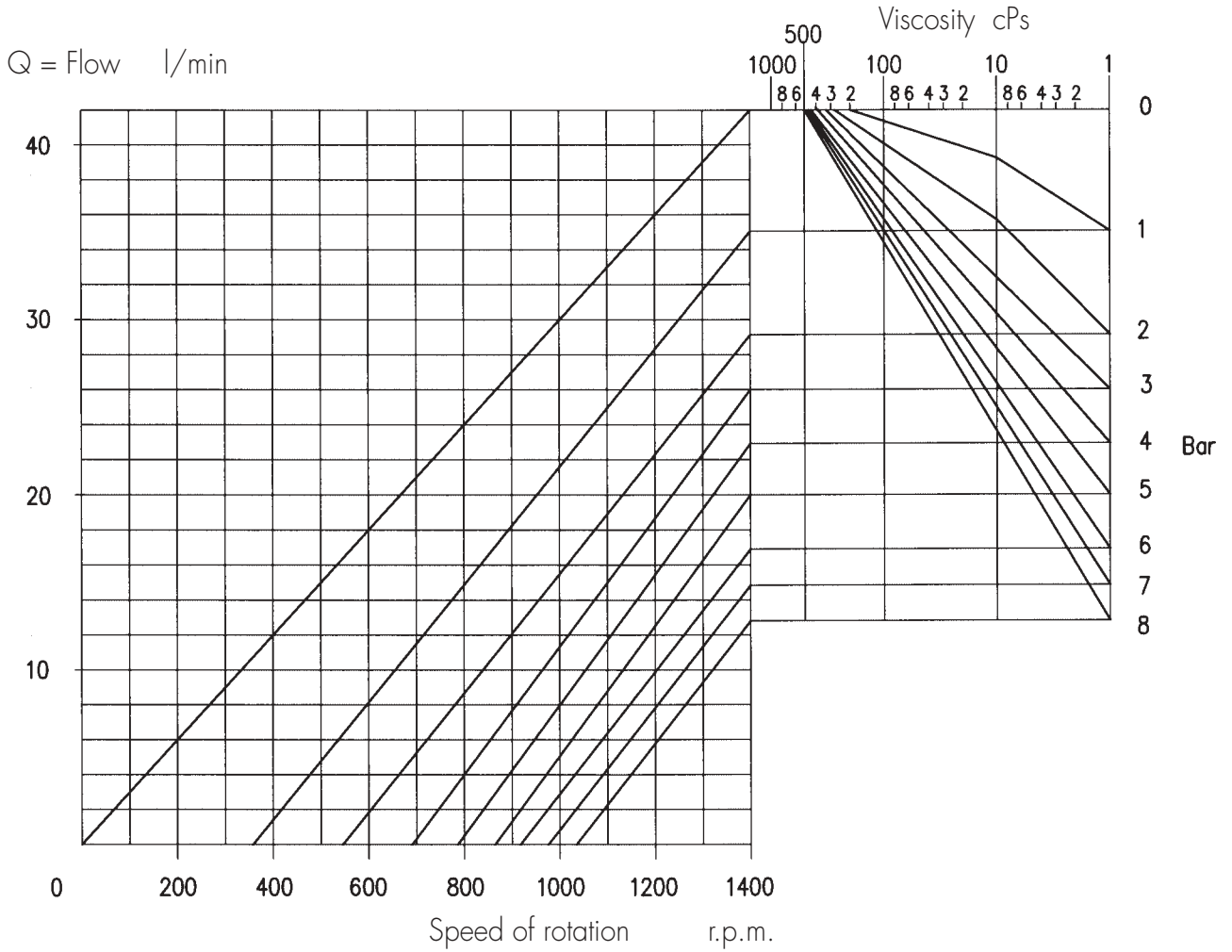

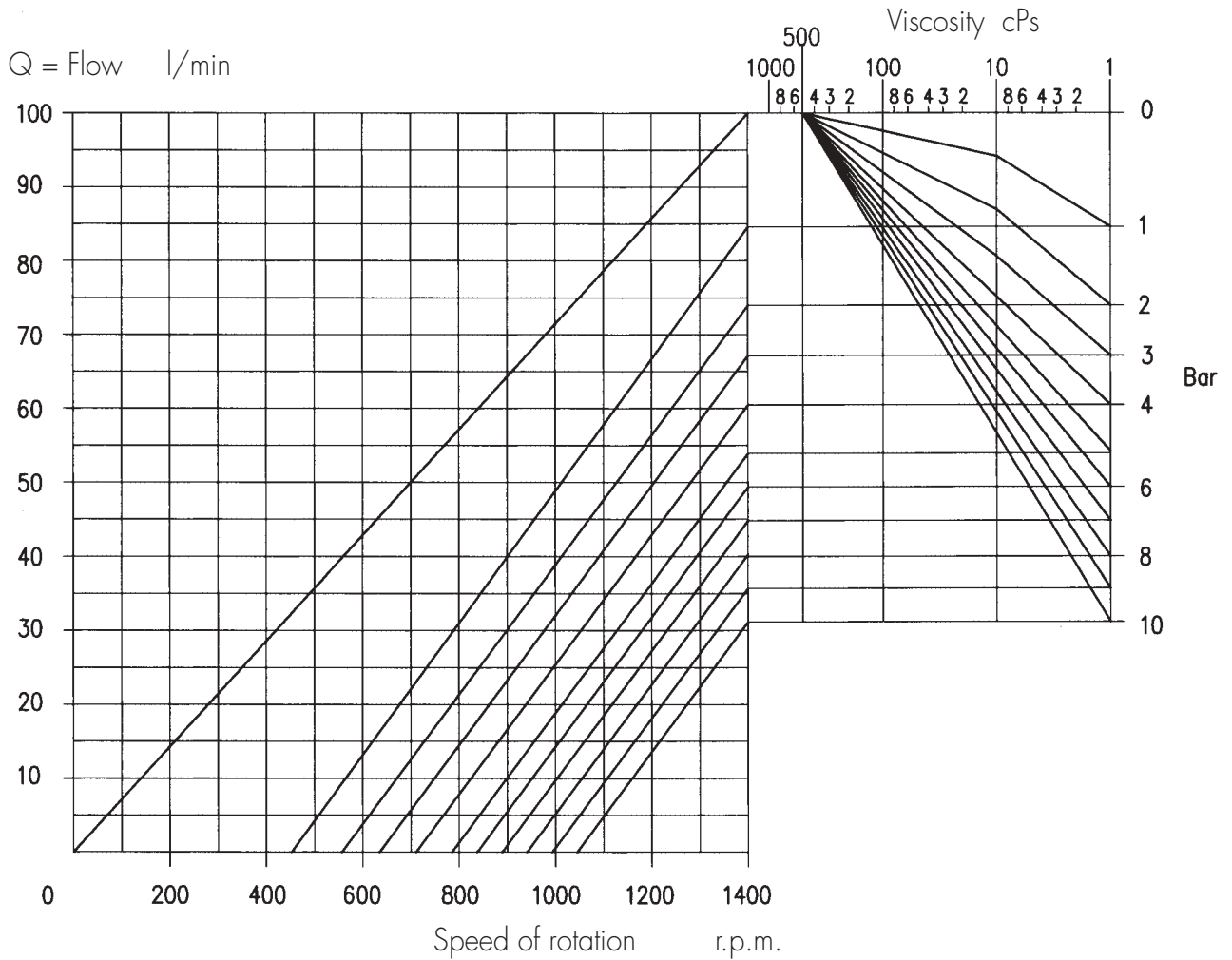

Kw = absorbed power

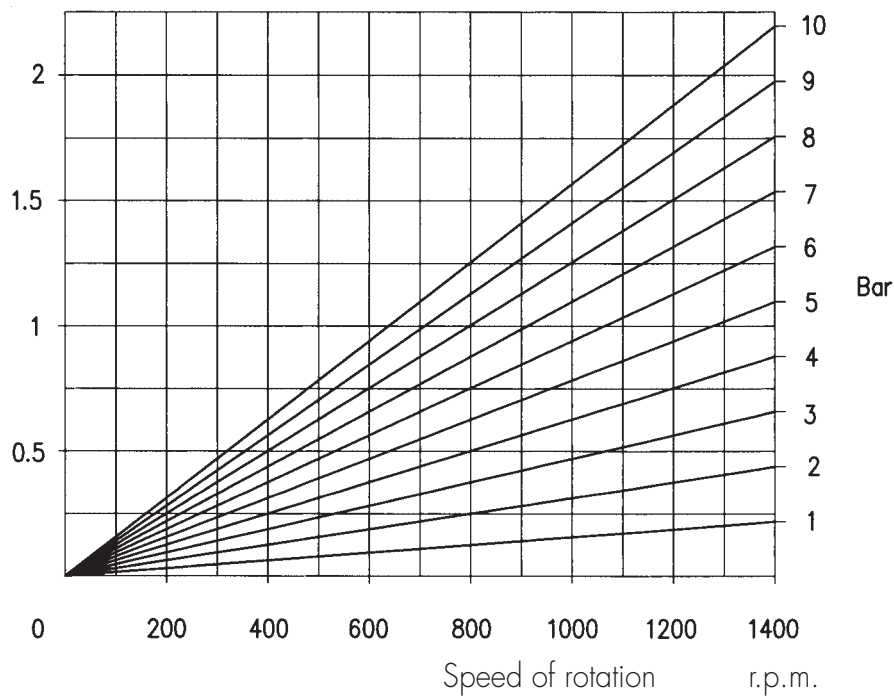



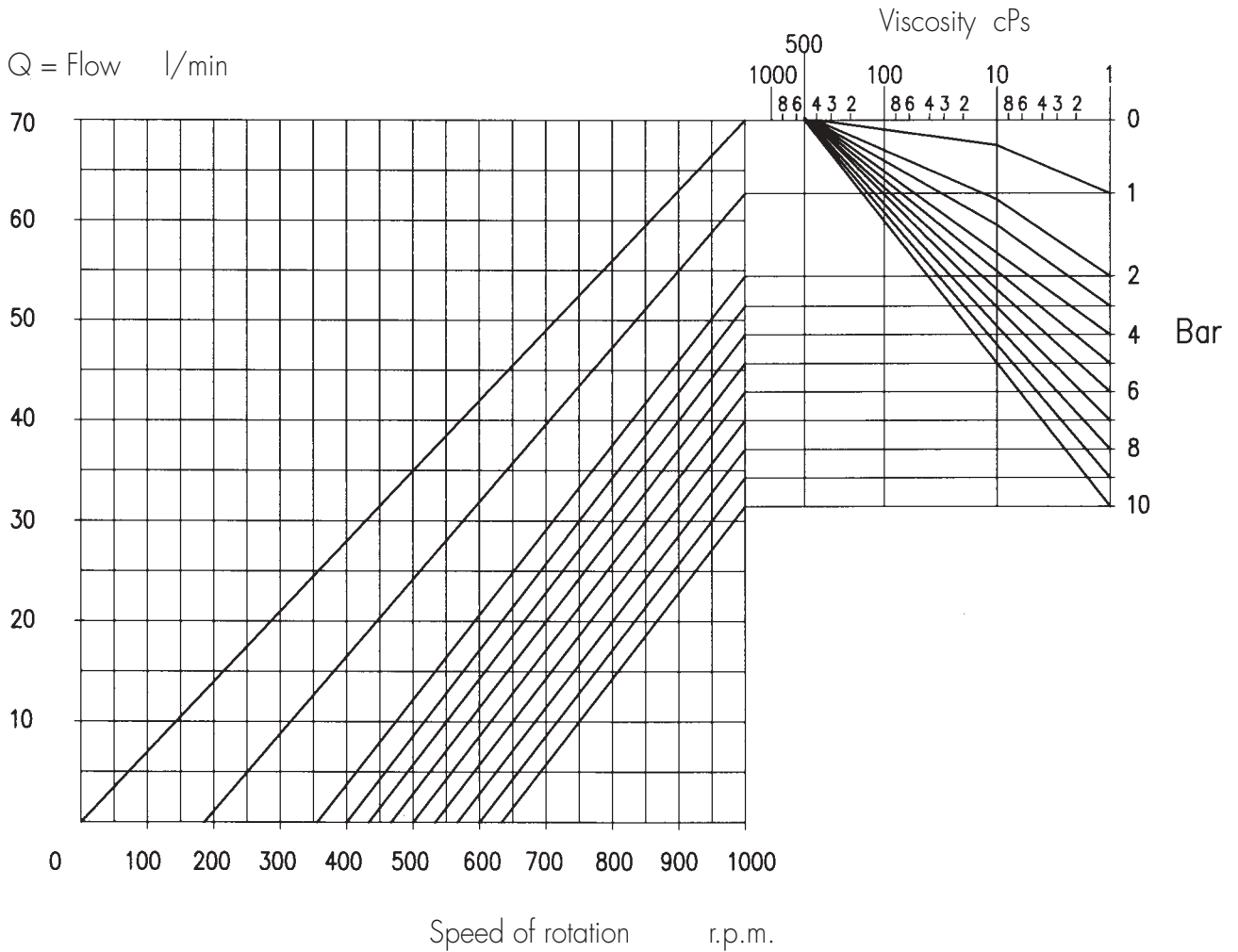

Kw = Absorbed power

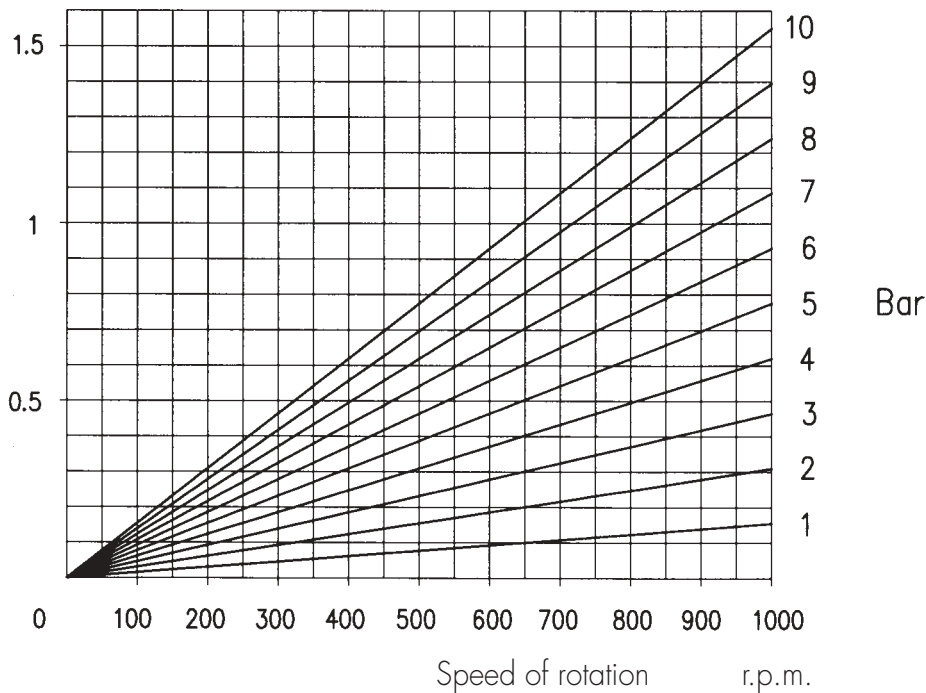

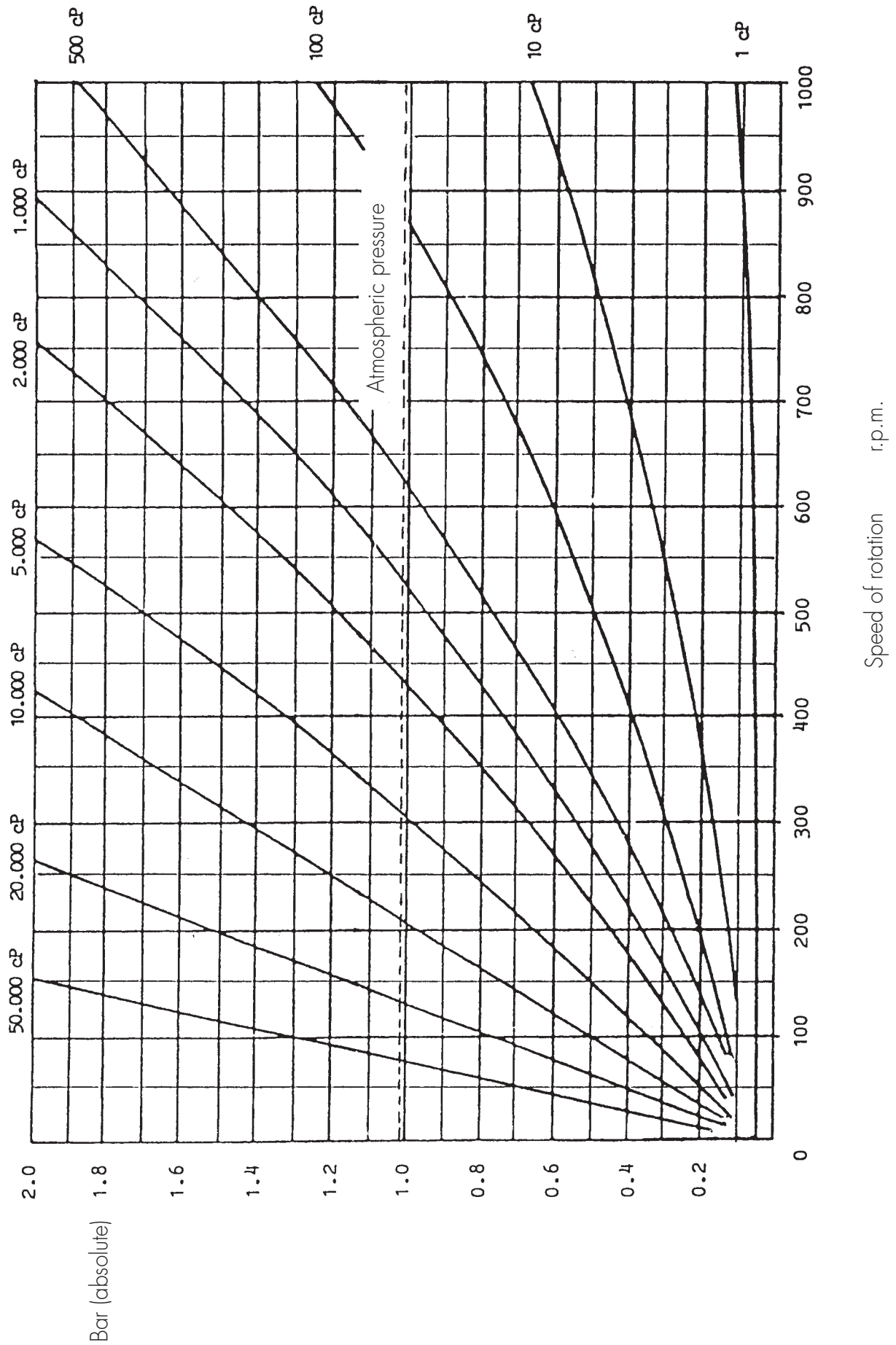

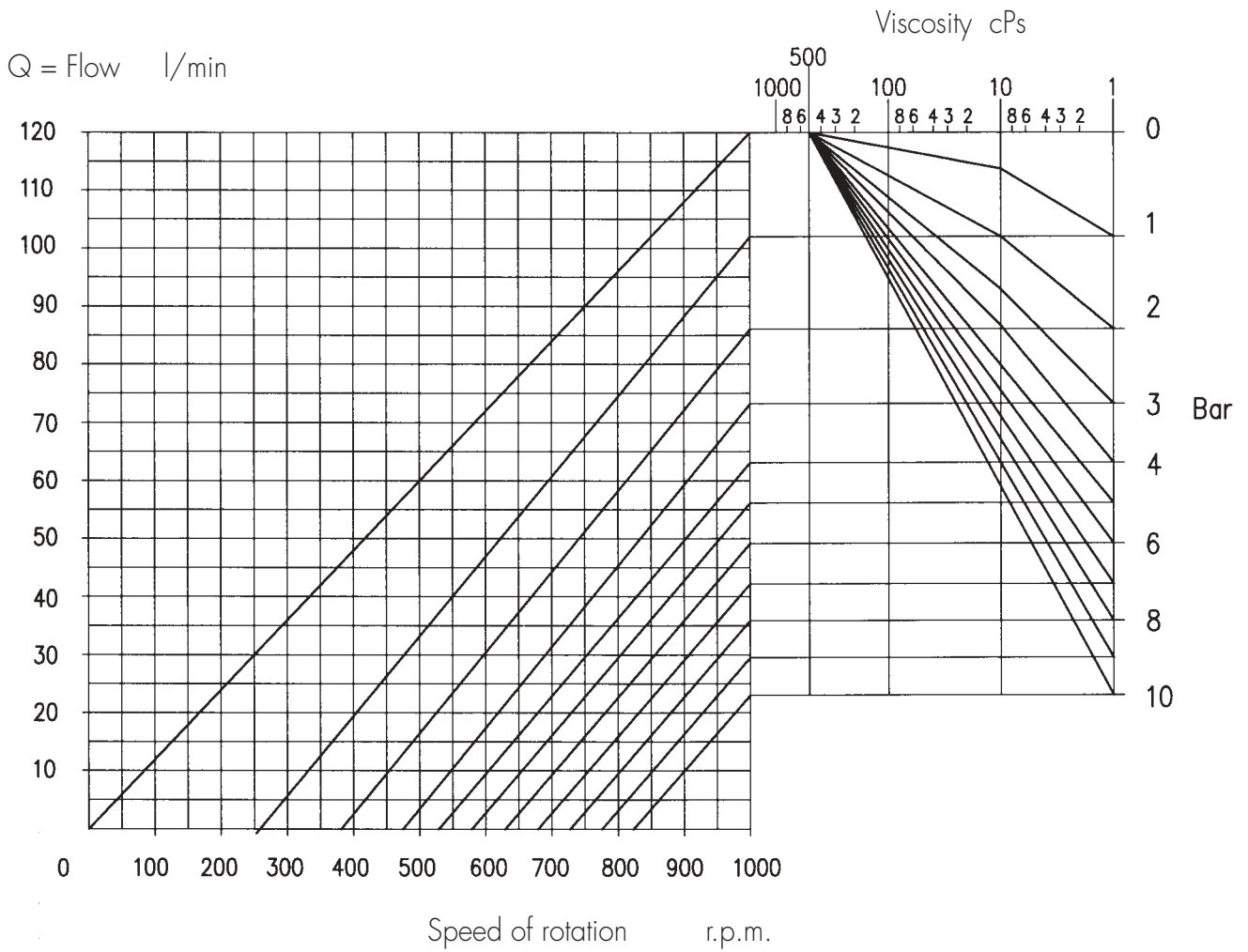

Kw = absorbed power

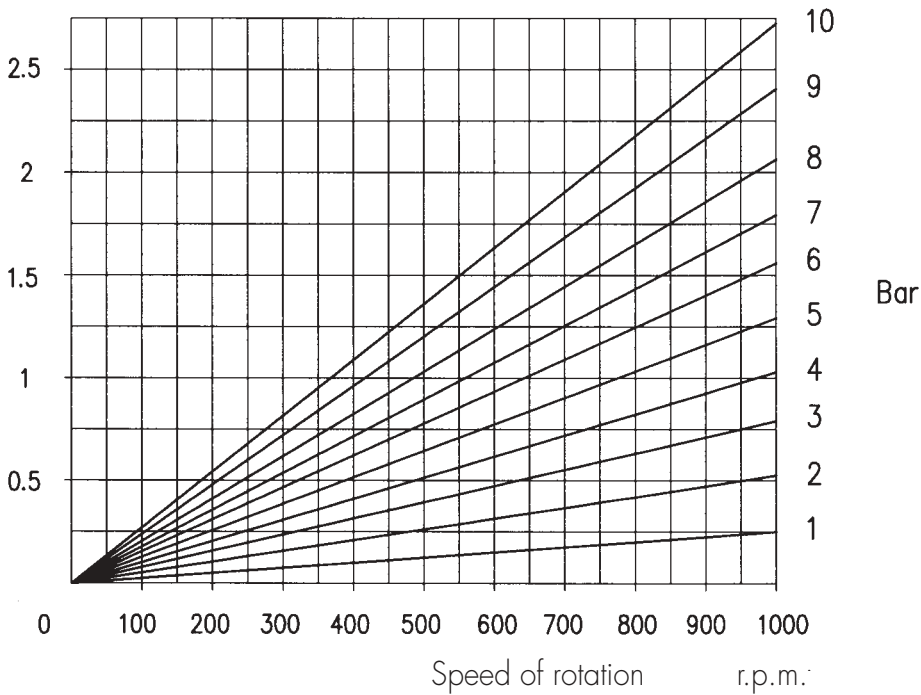

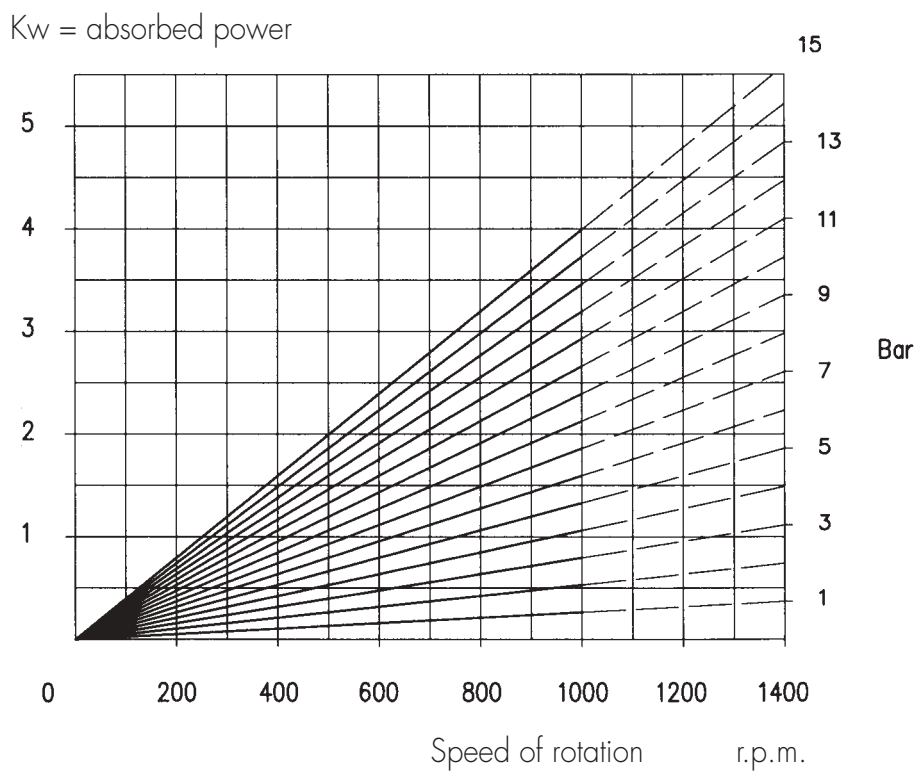
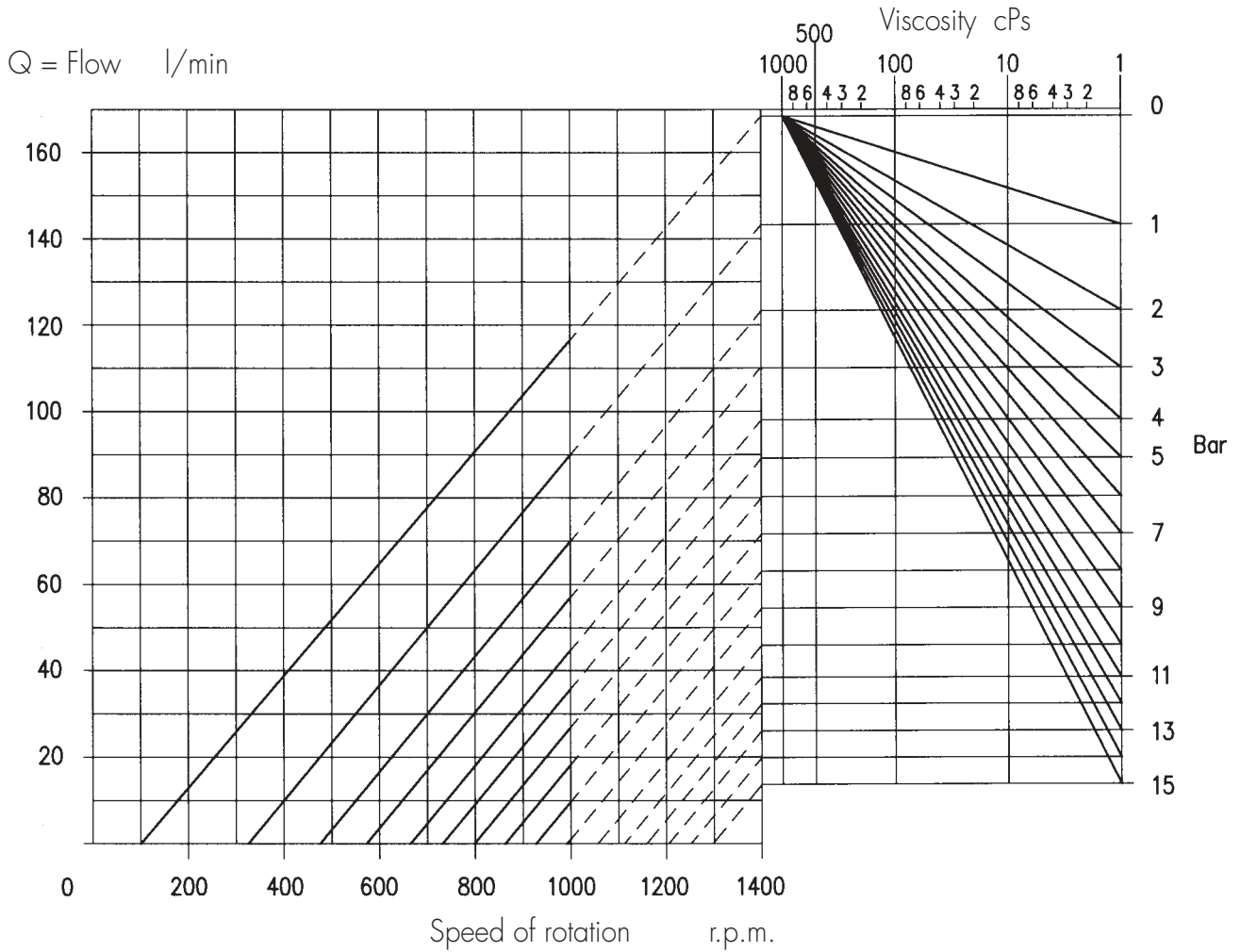

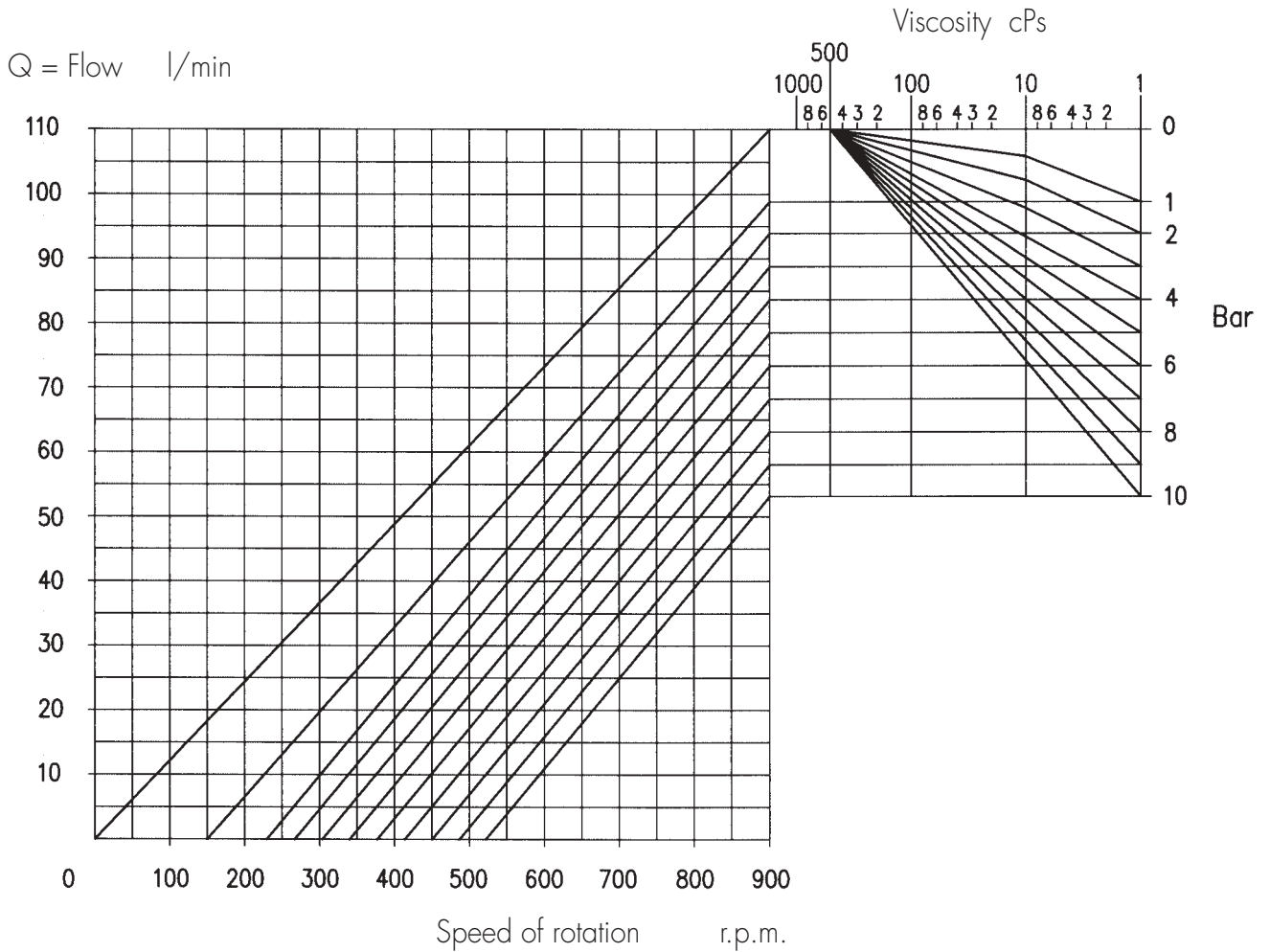

Kw = Absorbed power

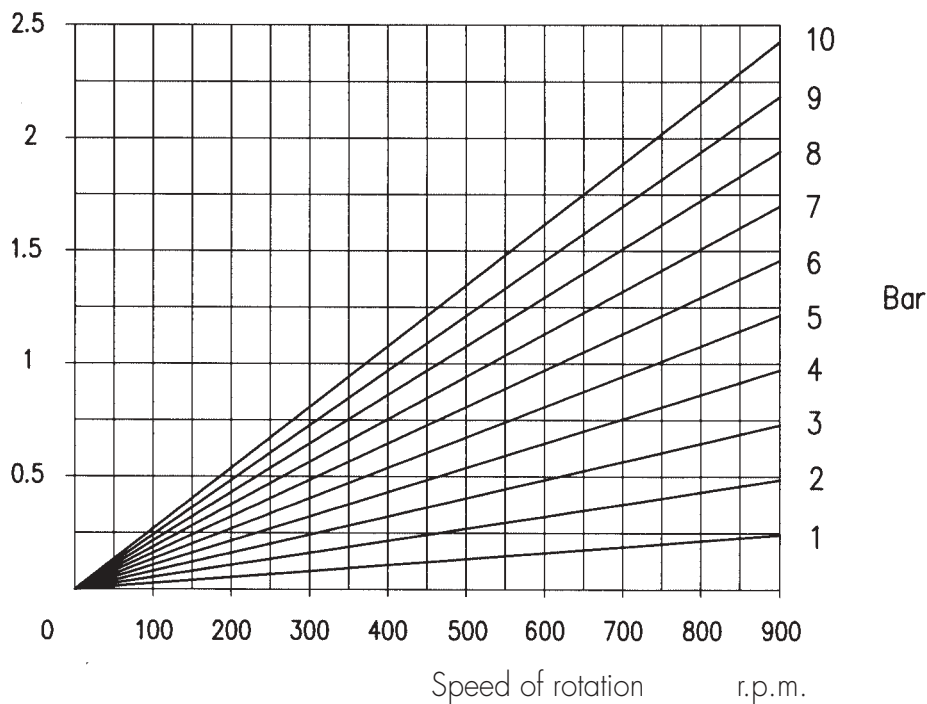

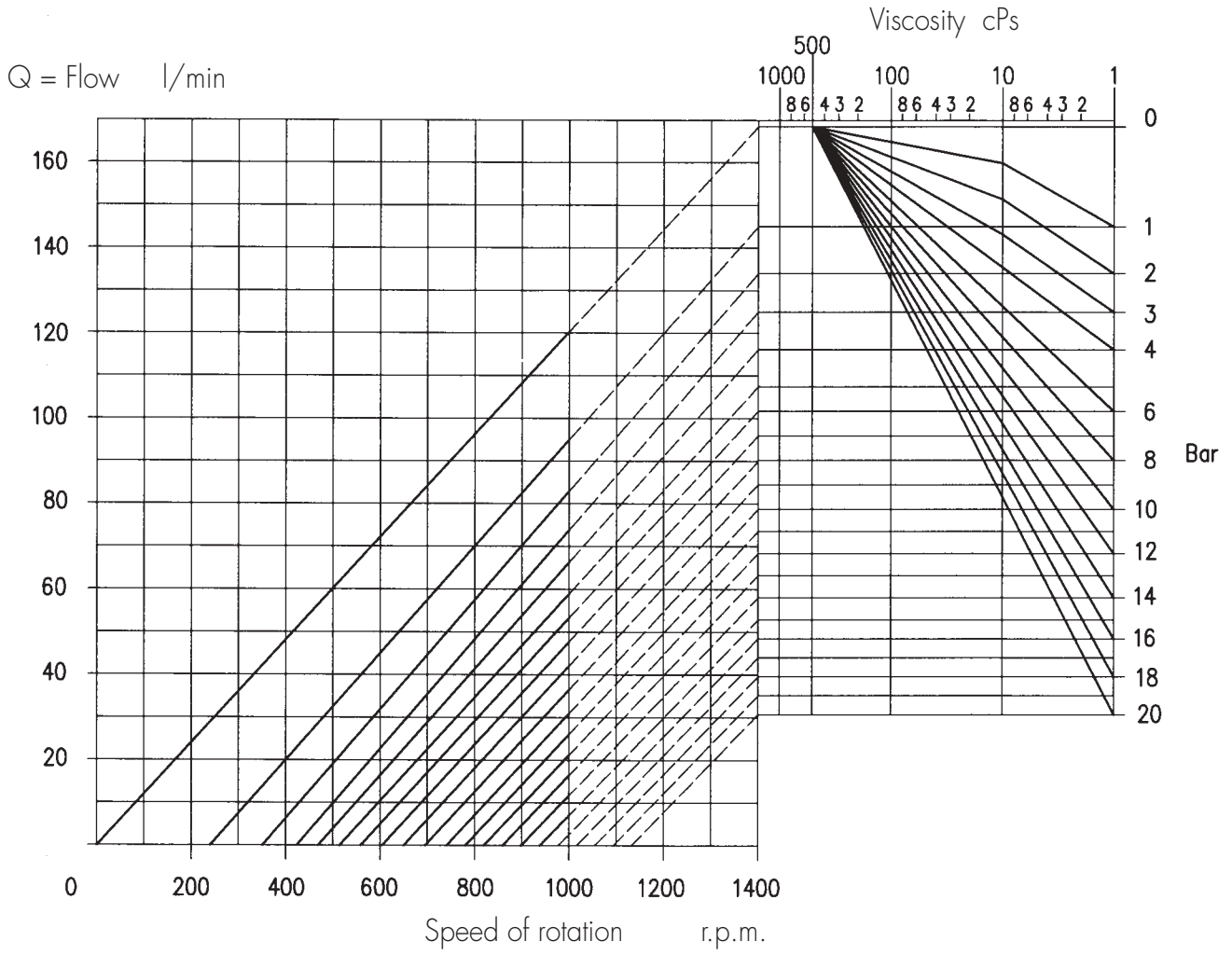

Kw =

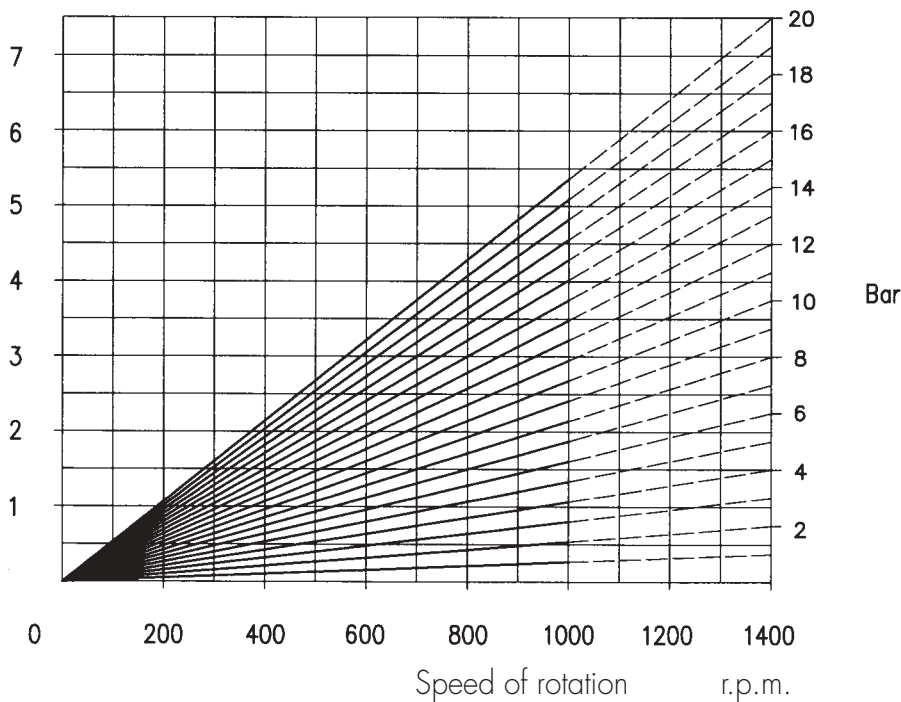

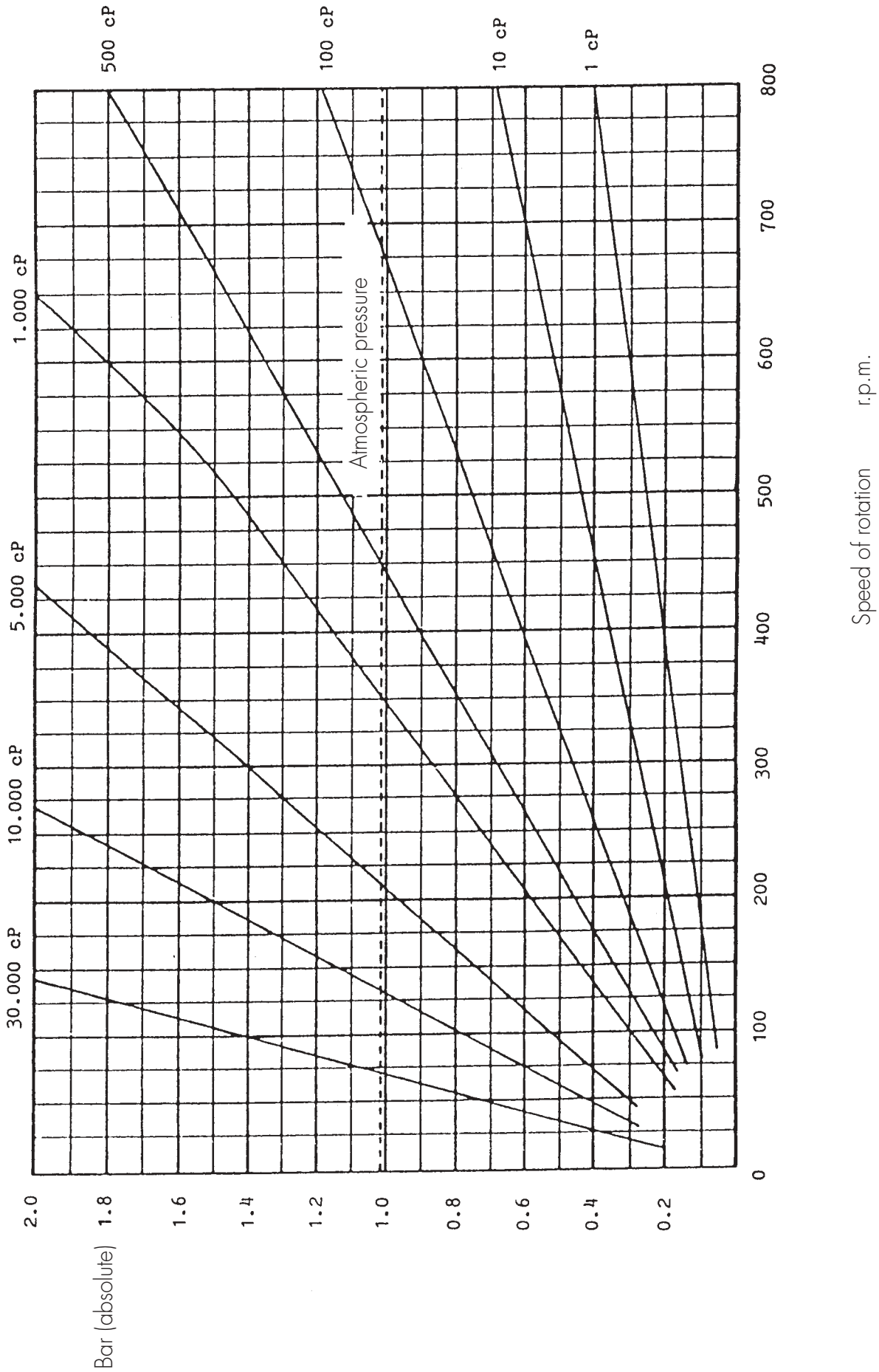

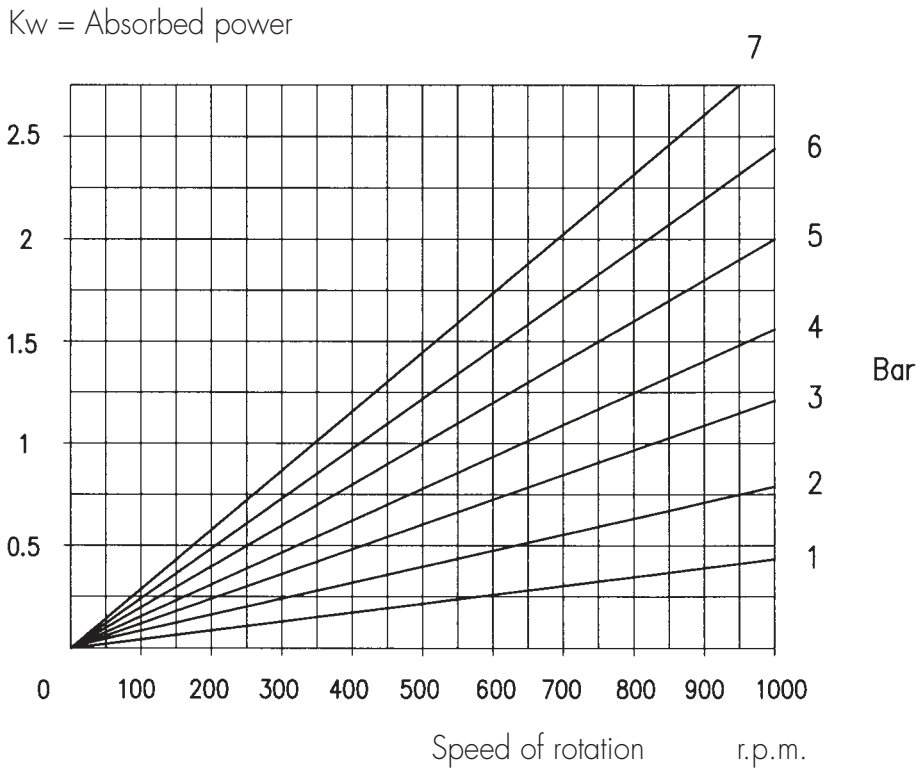
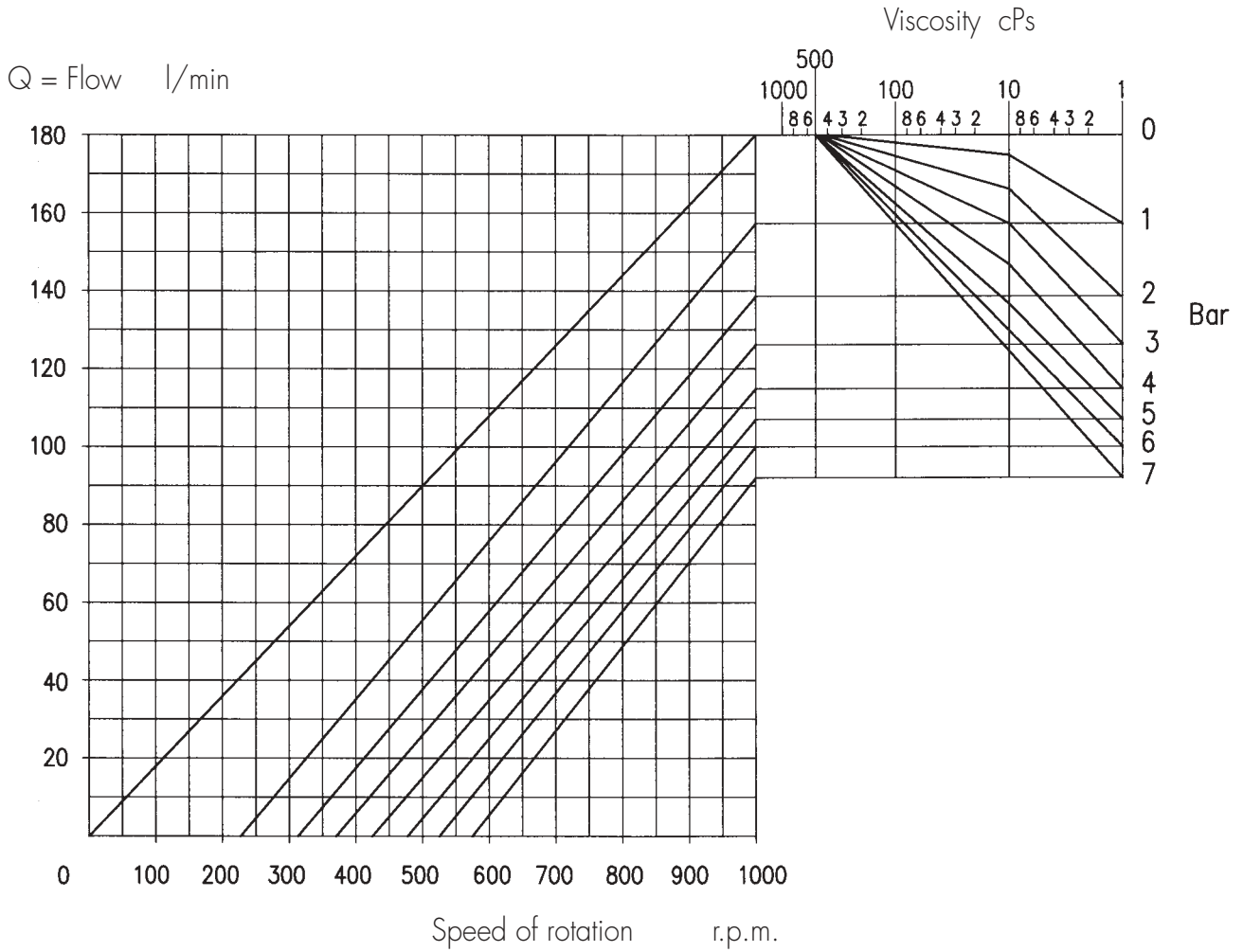



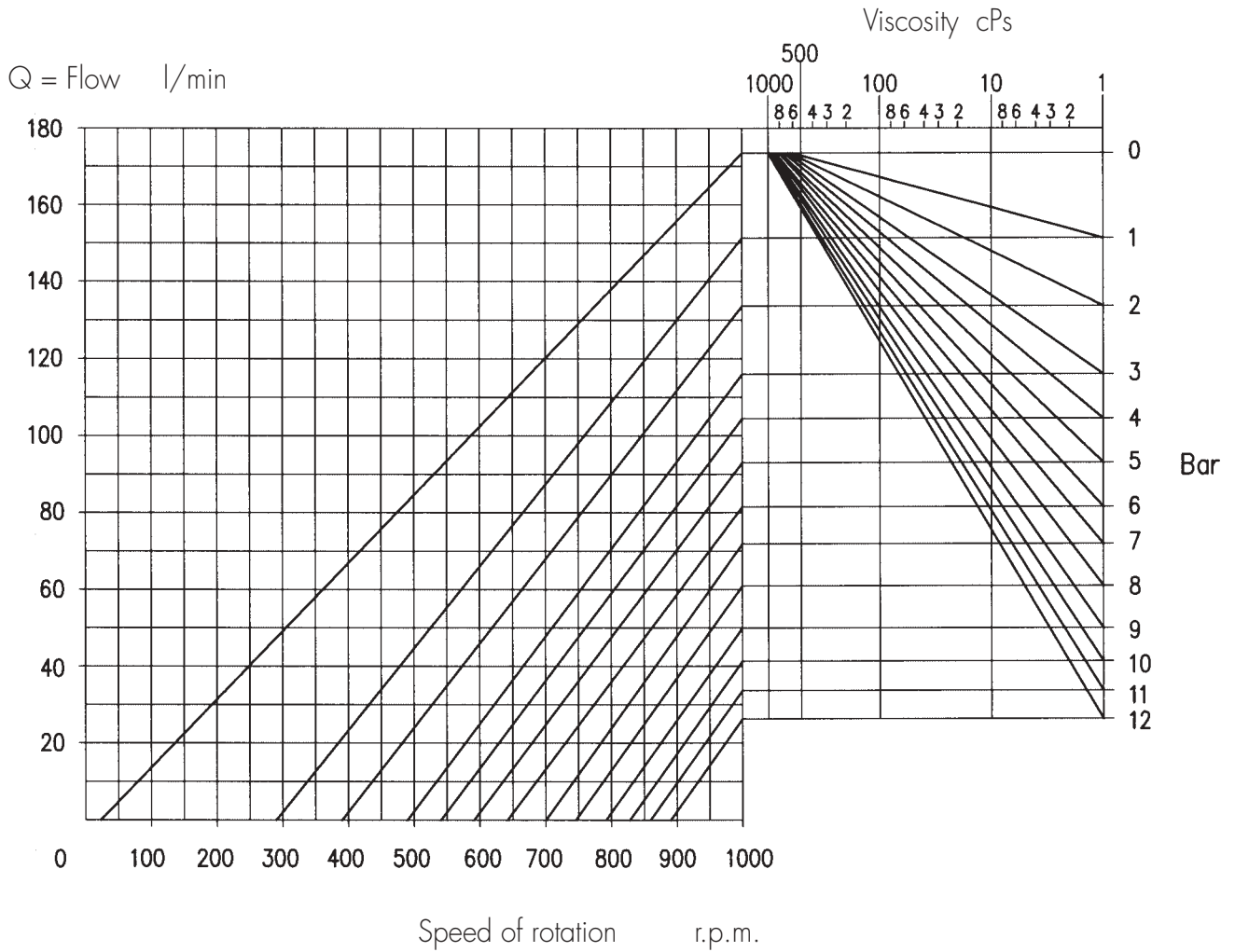

Kw = absorbed power

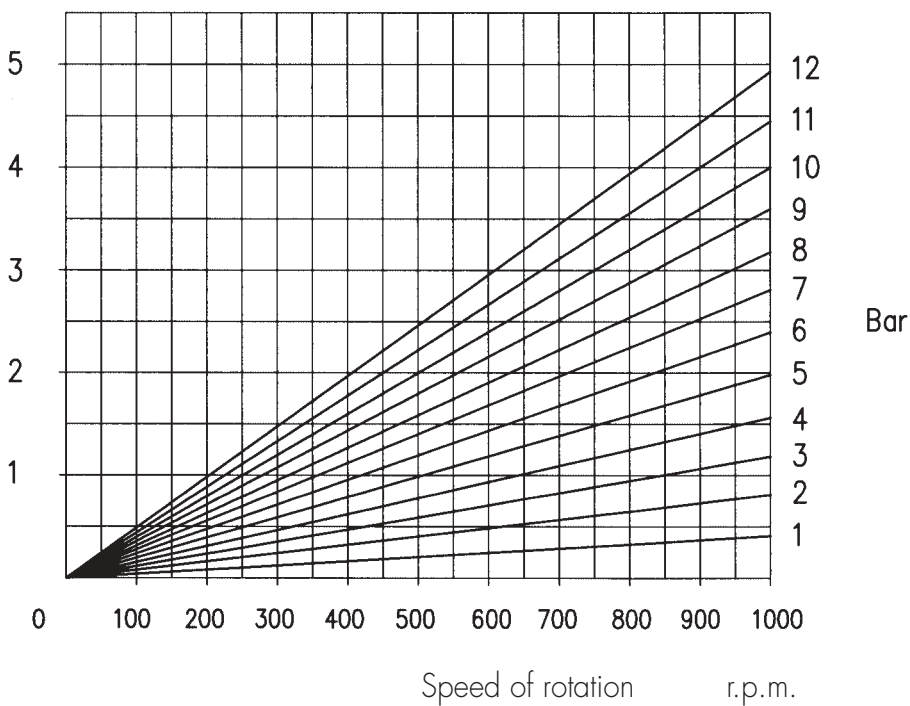

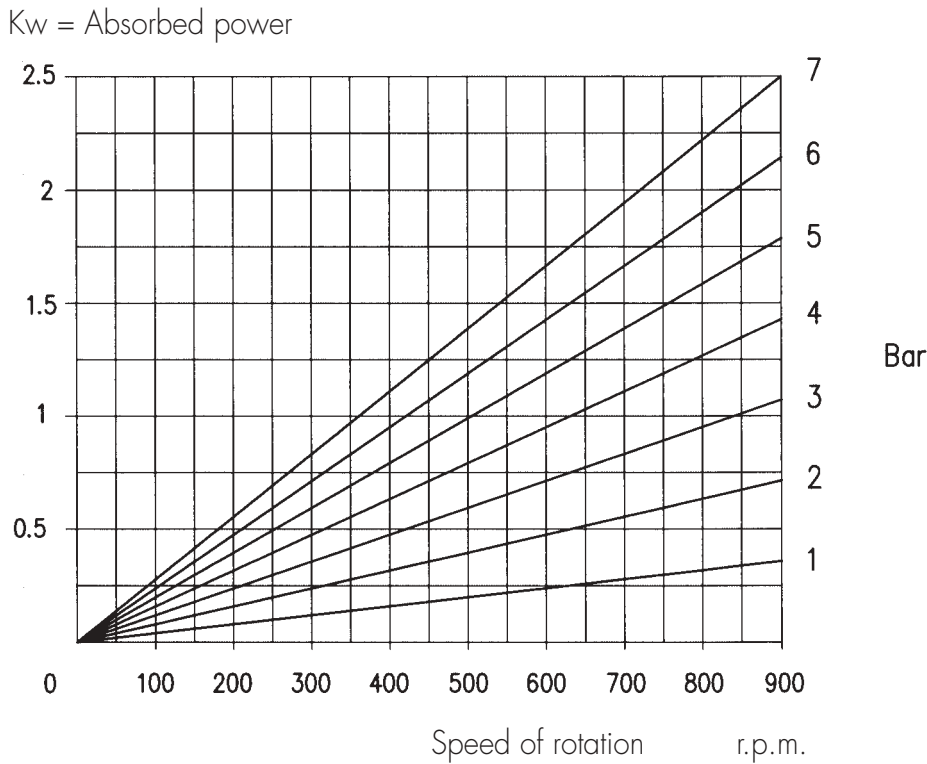
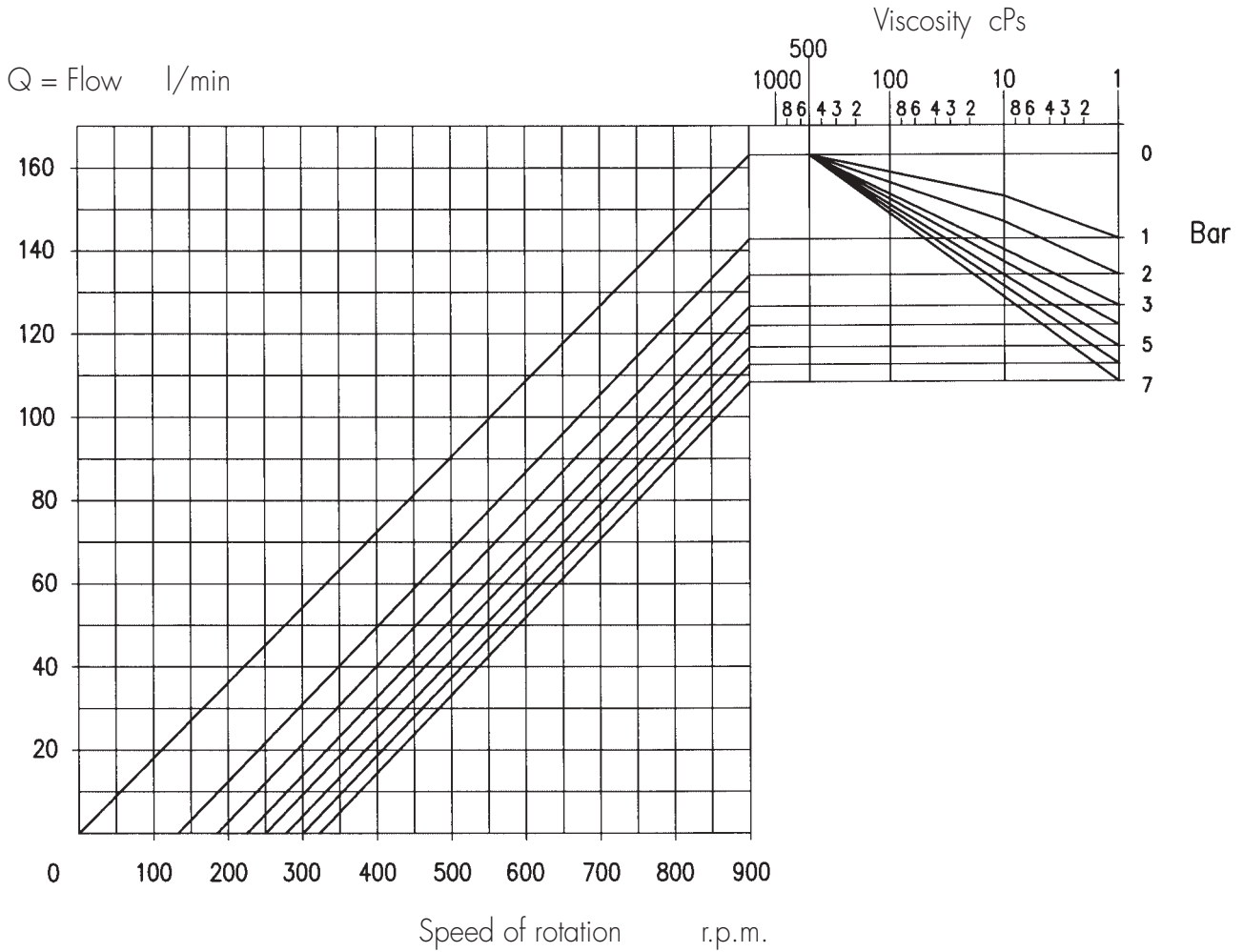

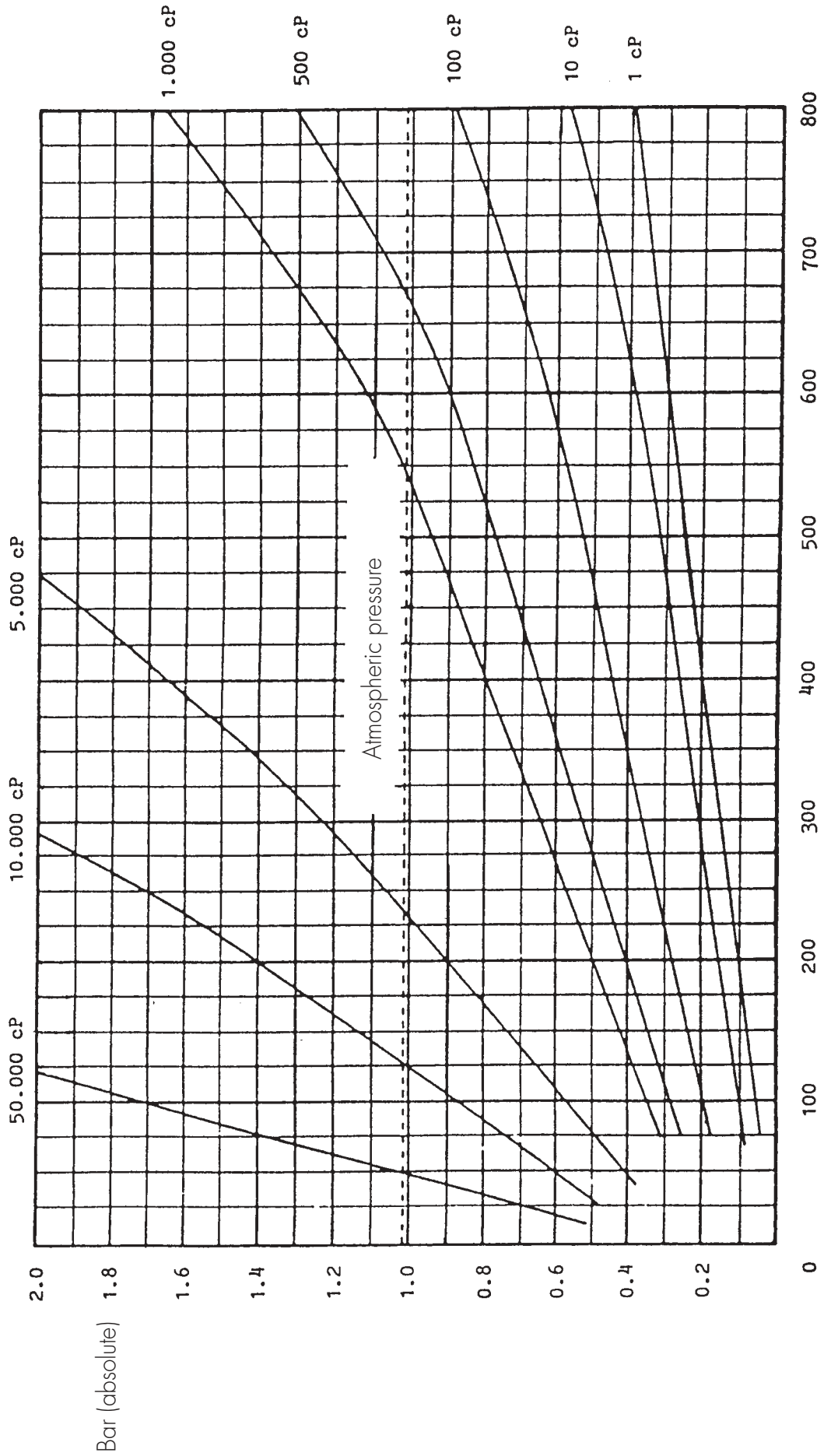

Speed of rotation r.p.m.

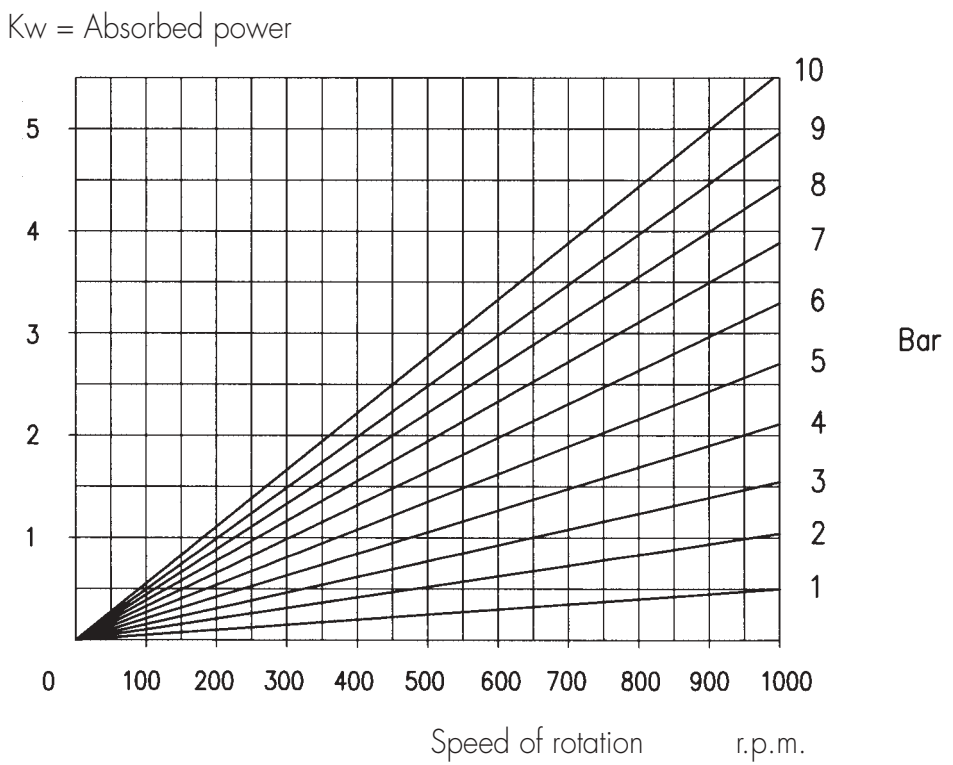
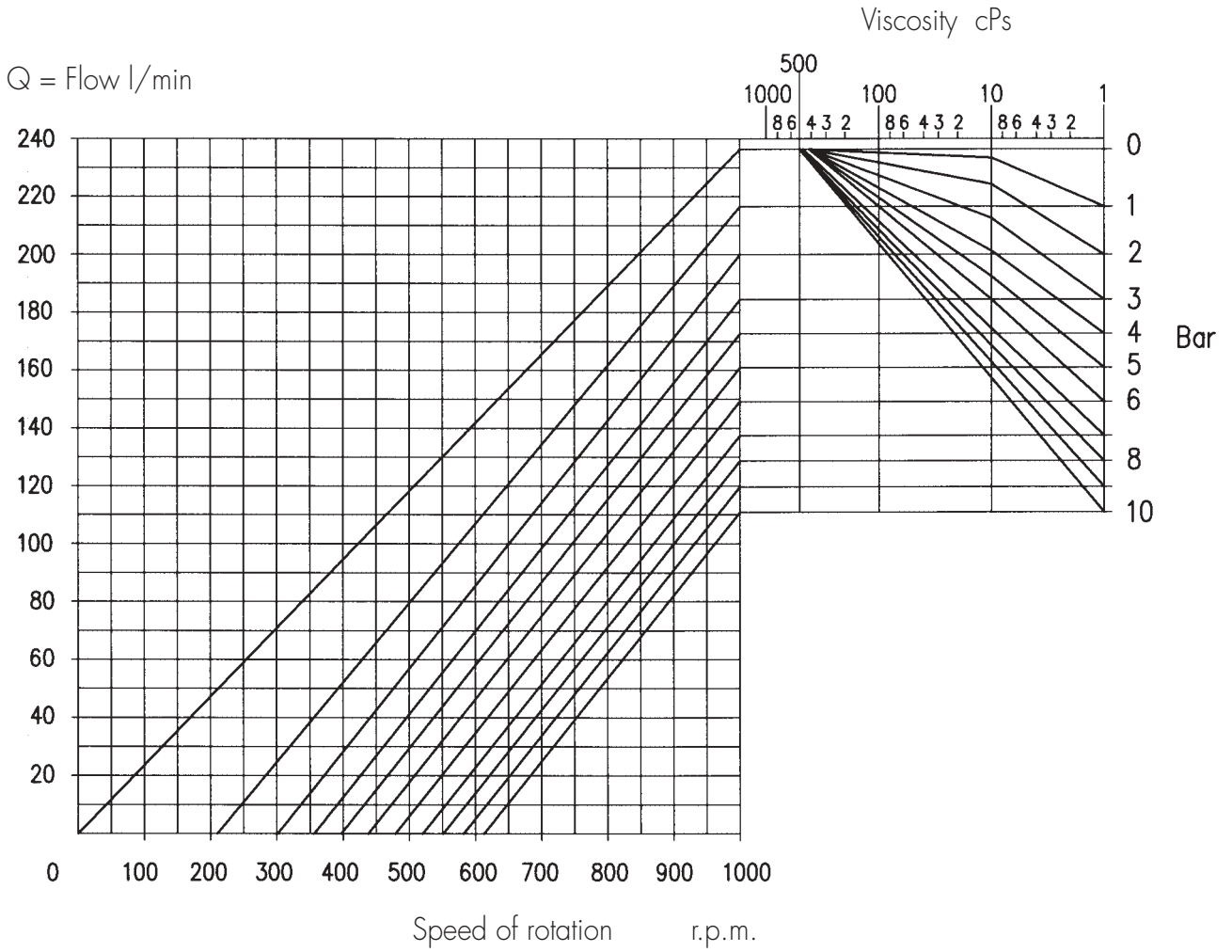

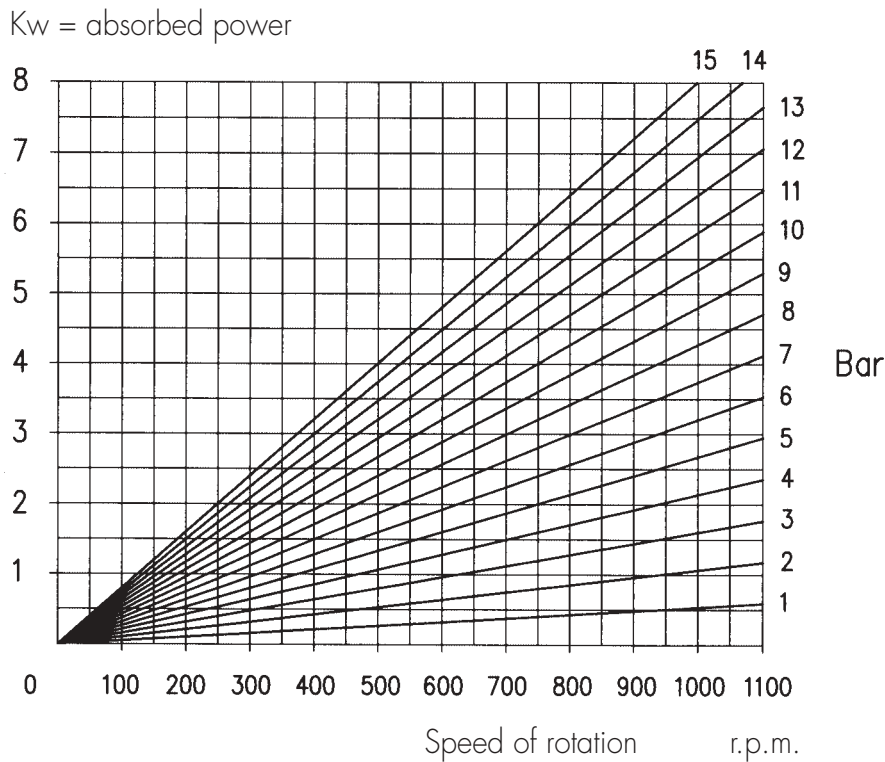
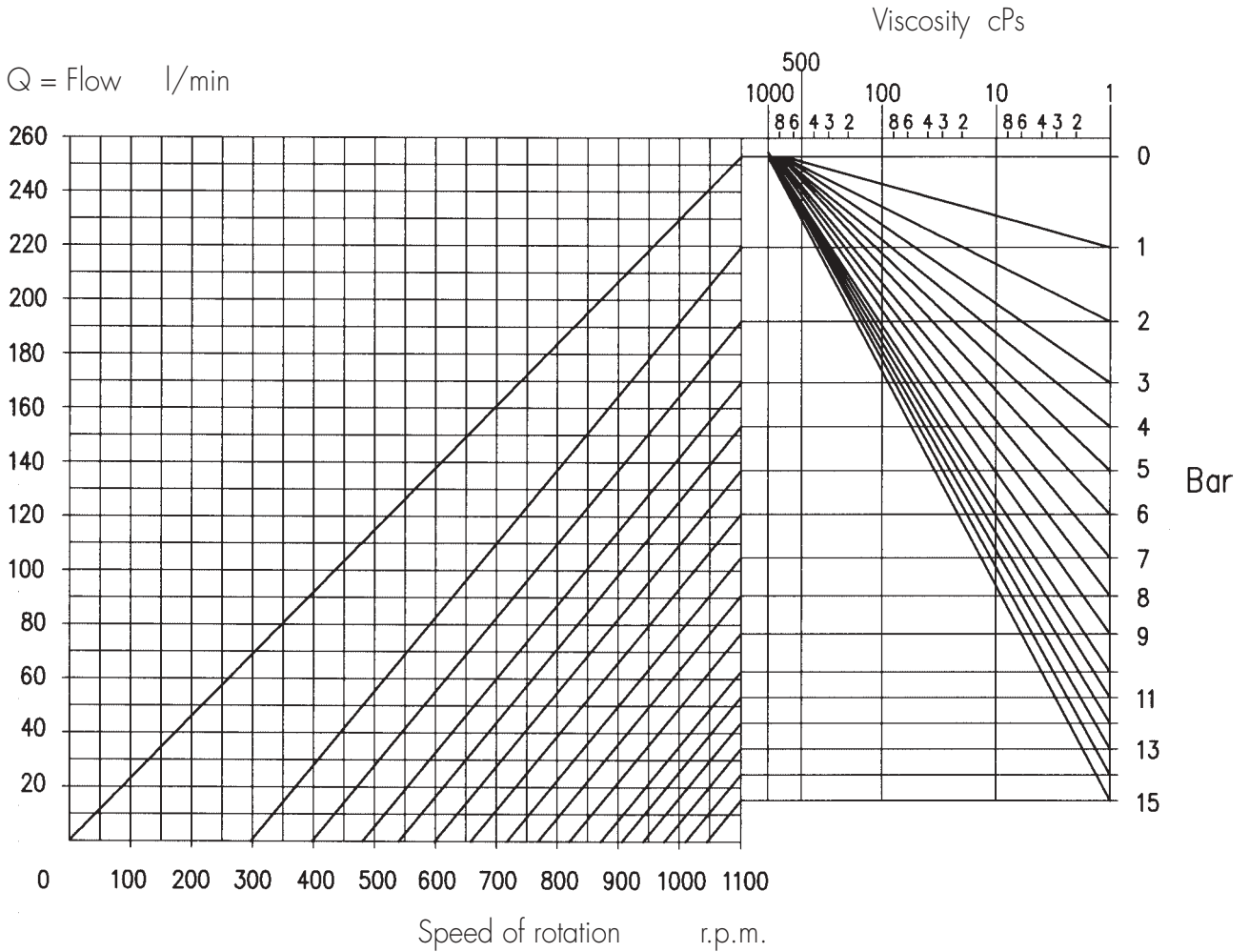

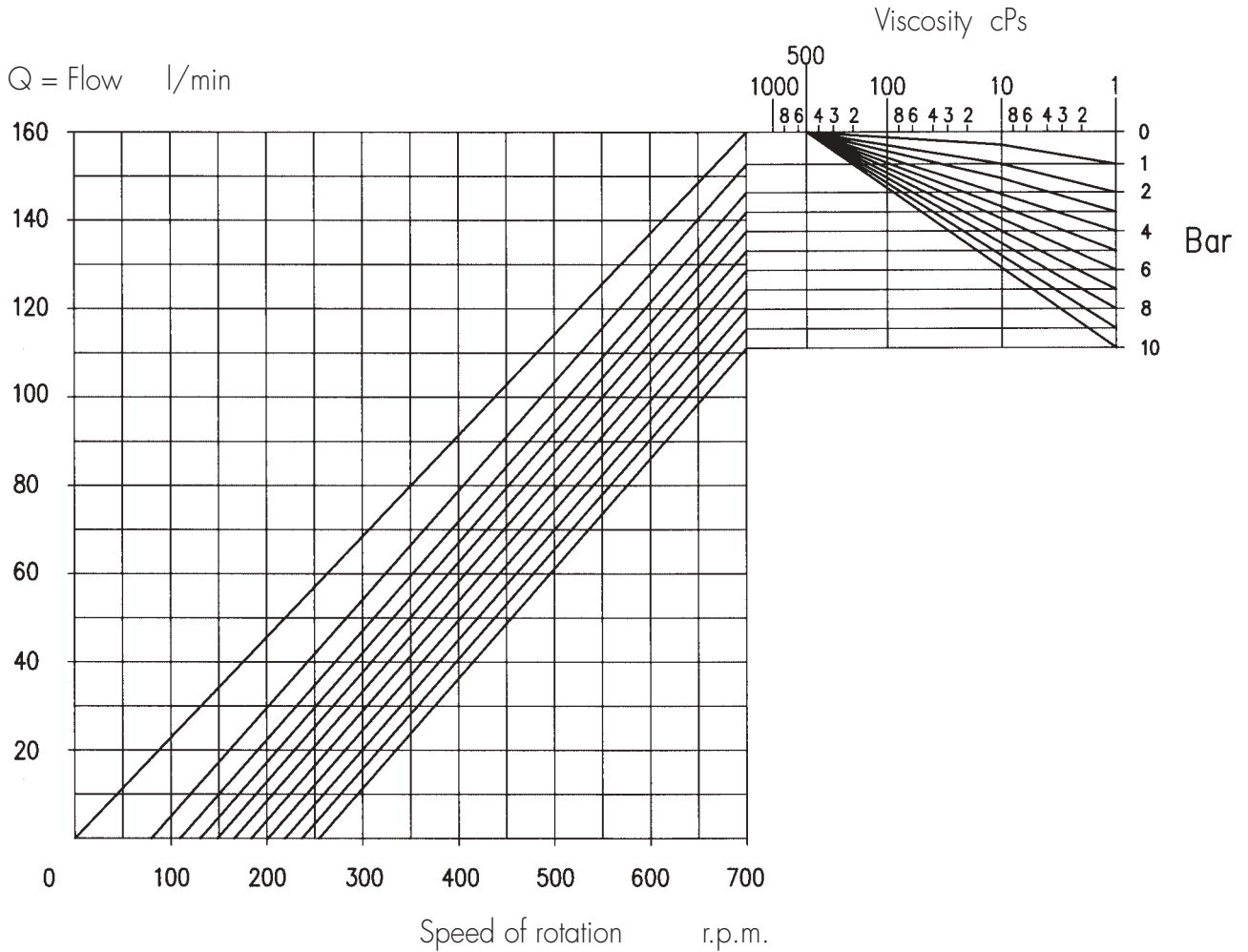

Kw = absorbed power

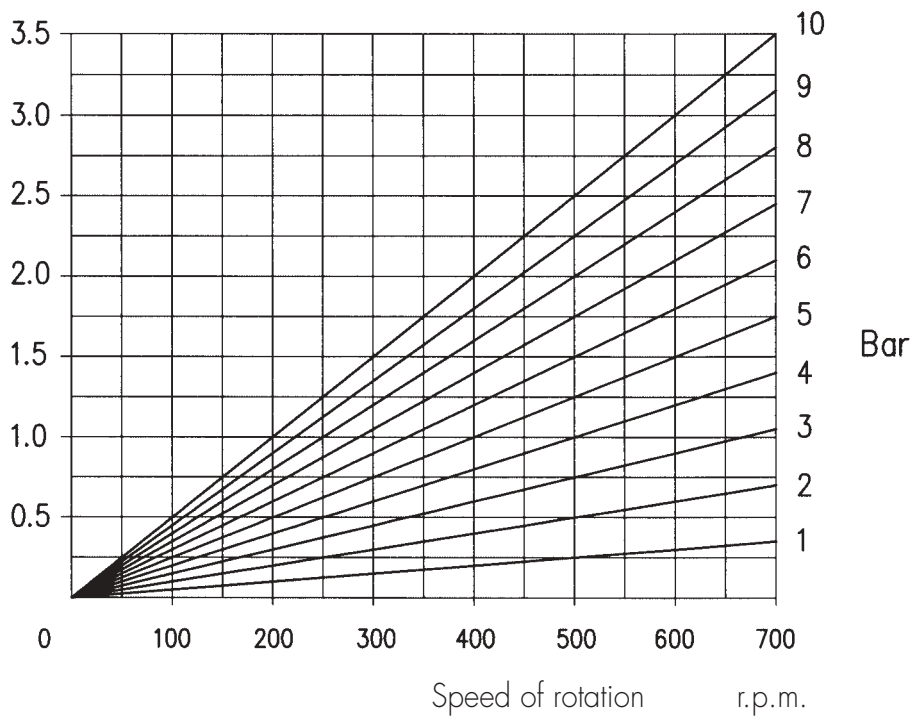

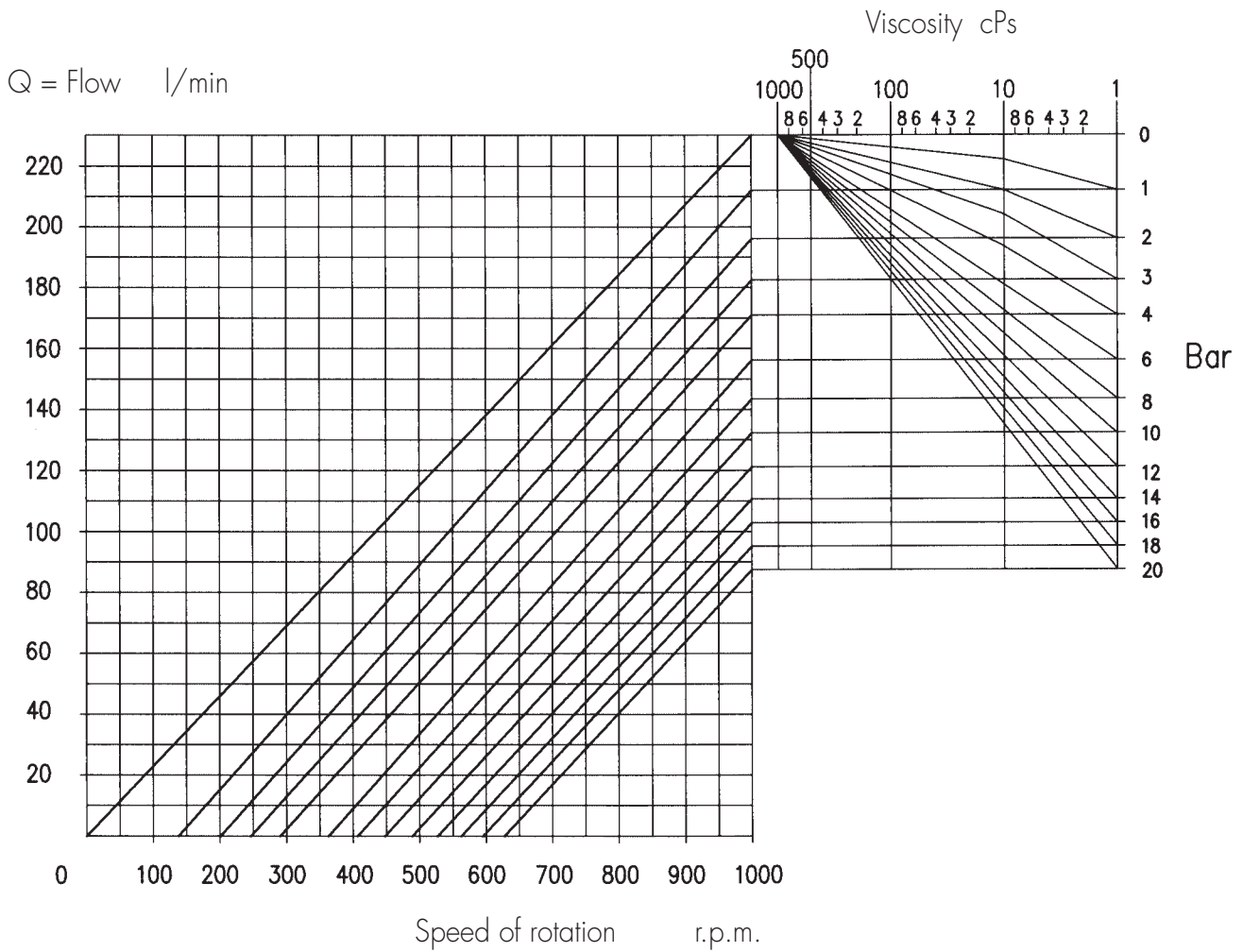

Kw = Absorbed power

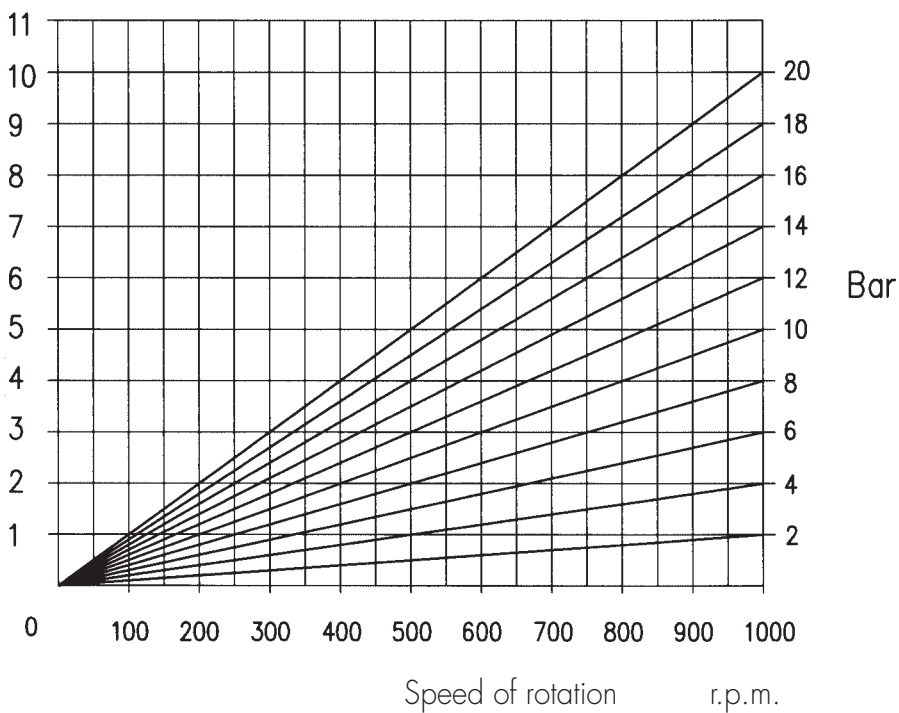

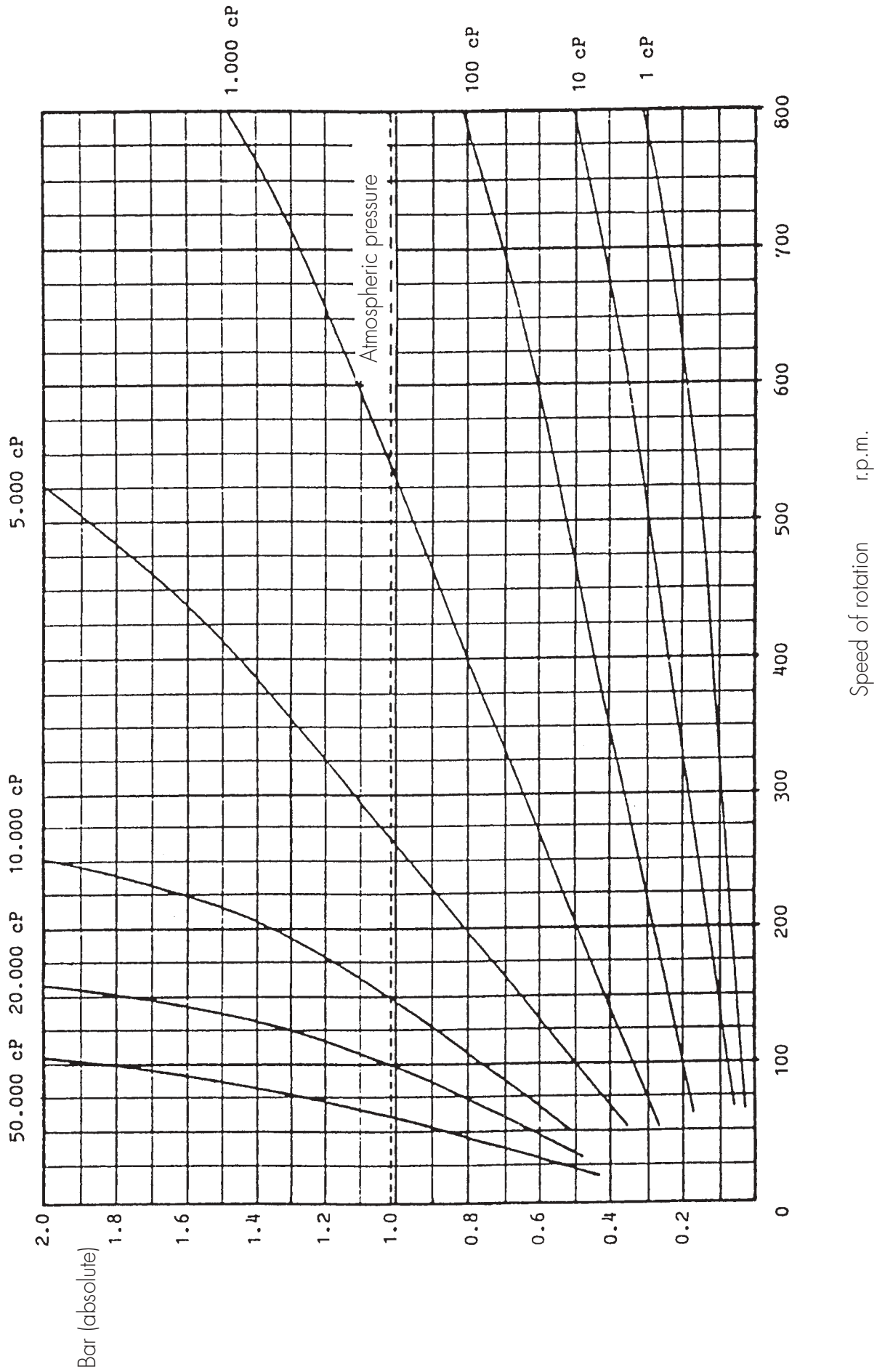



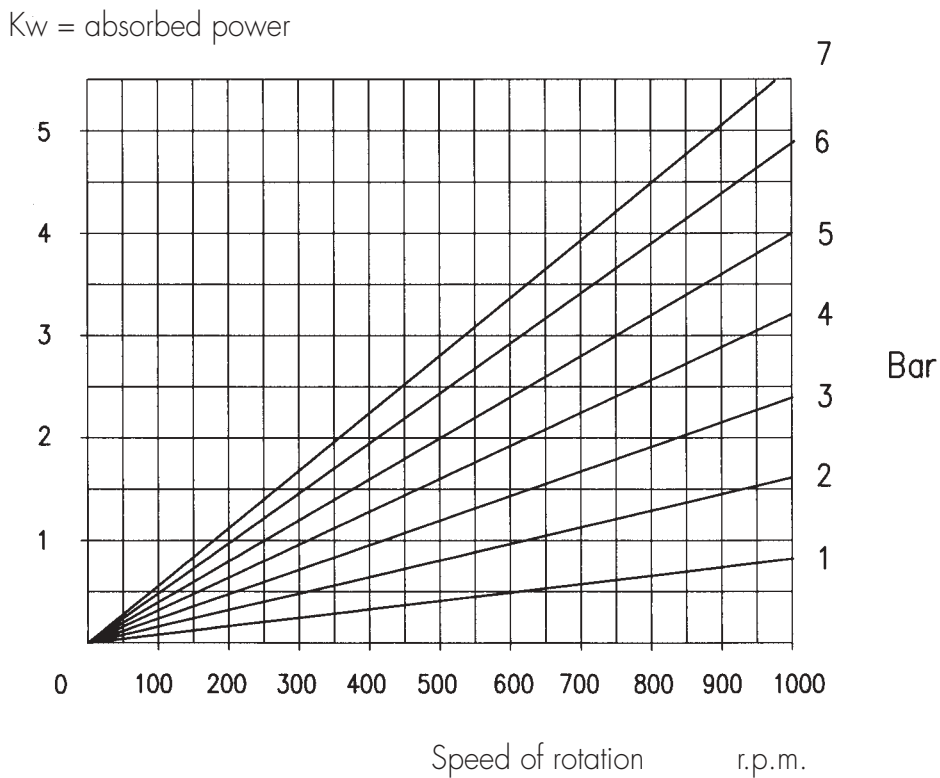
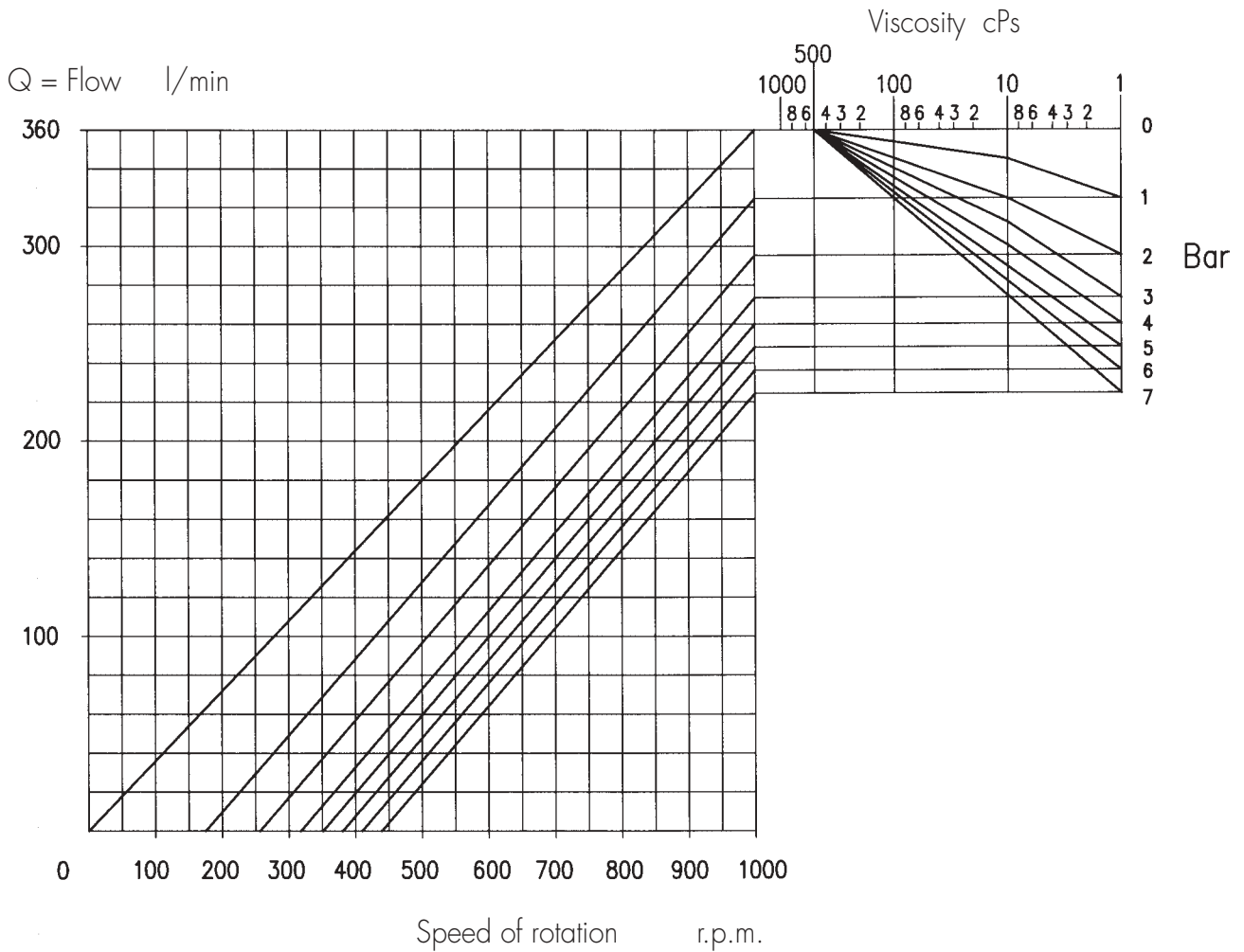

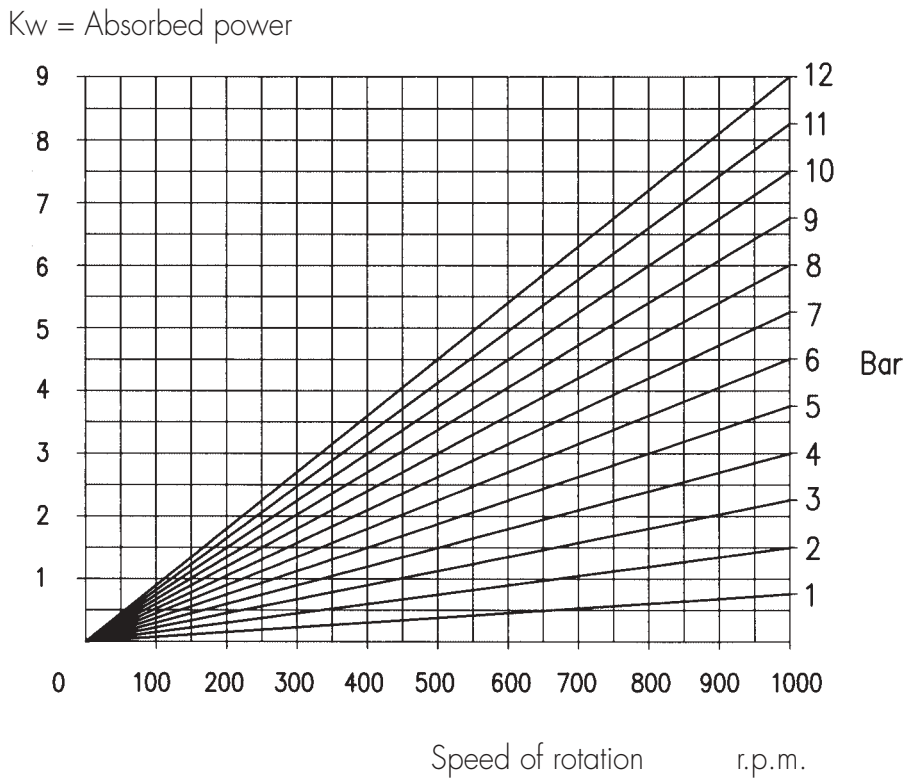
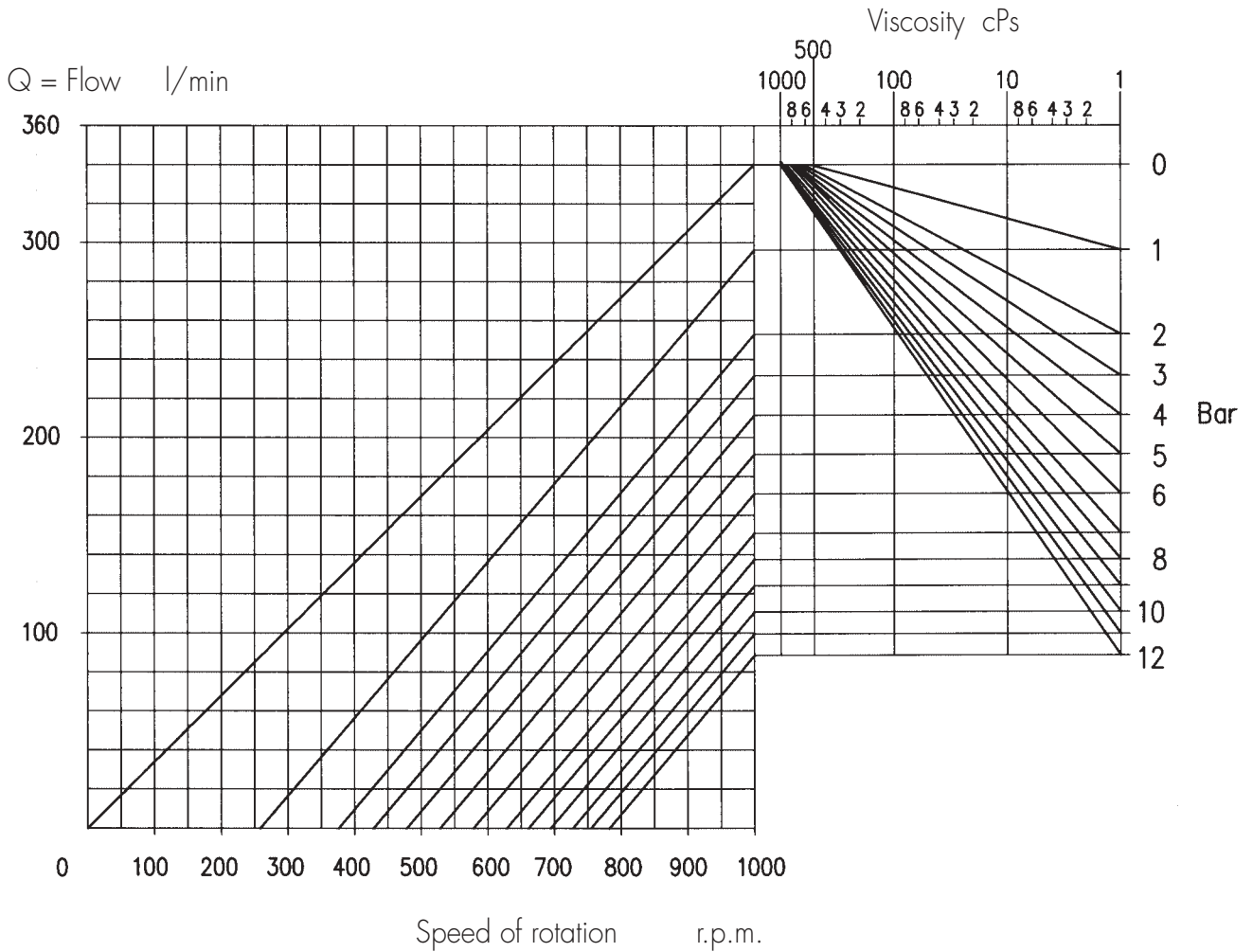

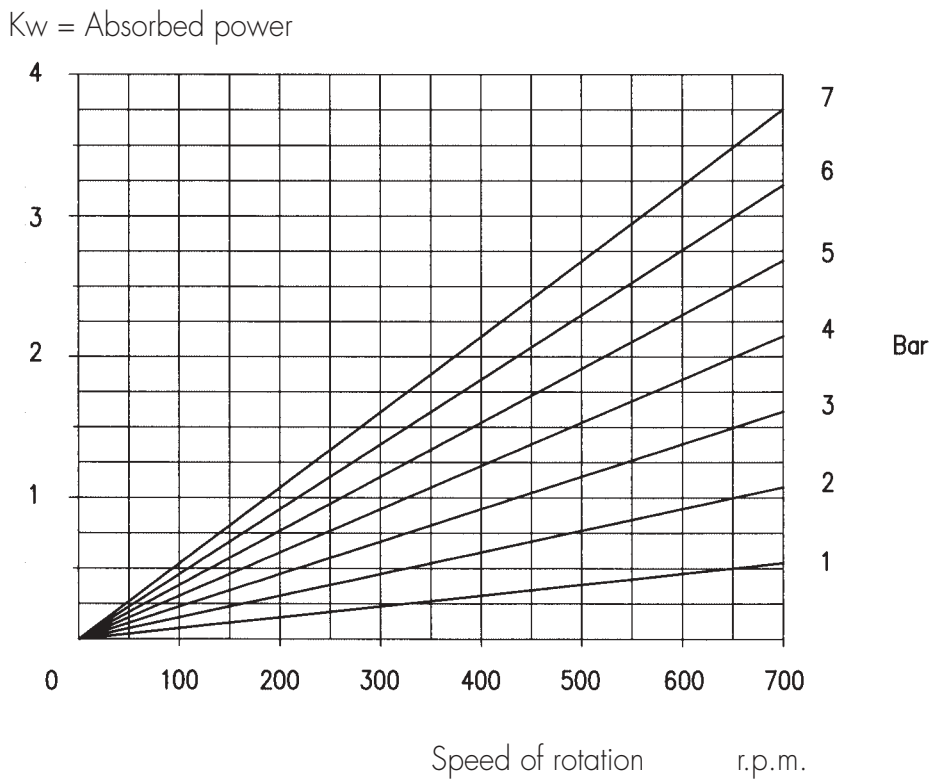
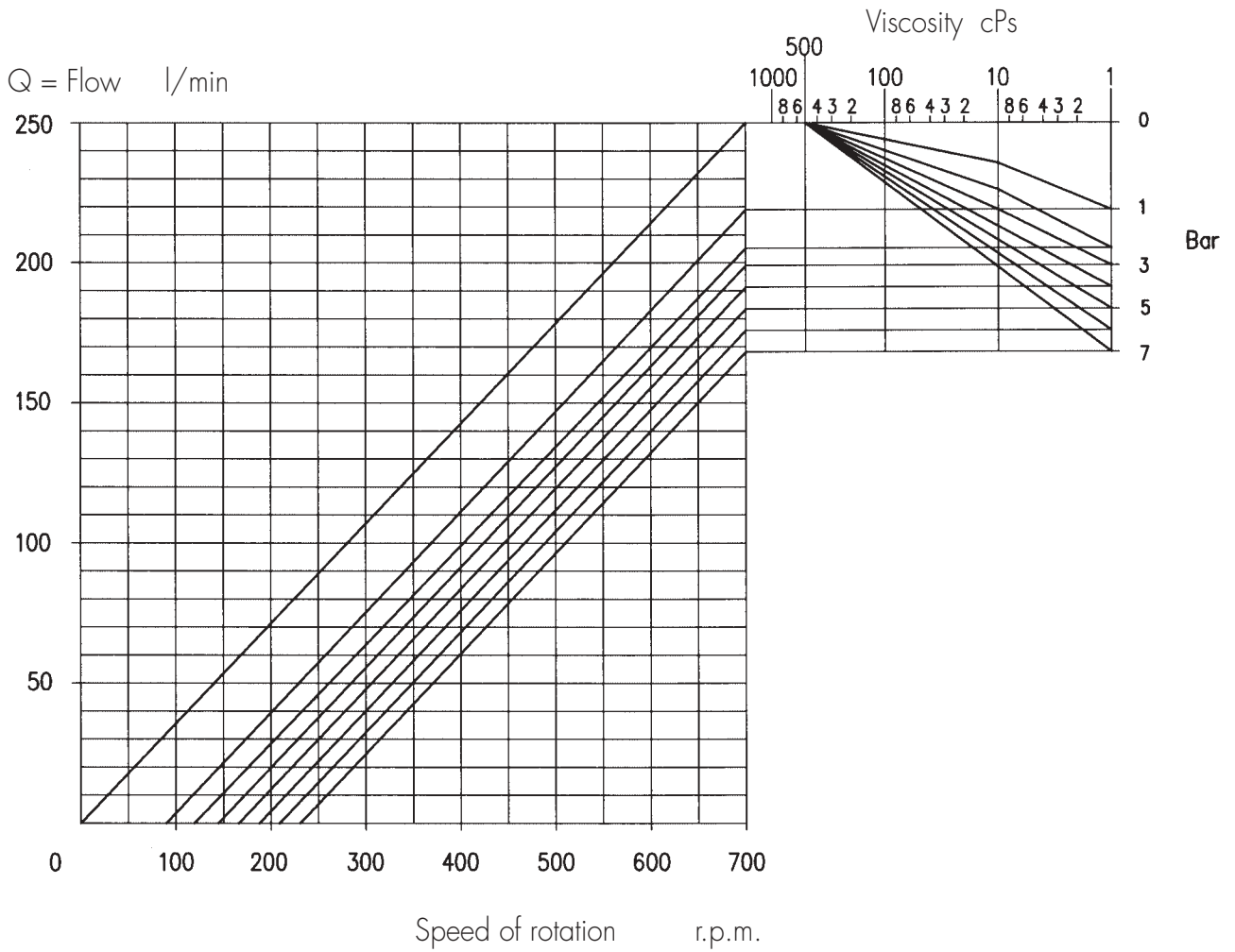

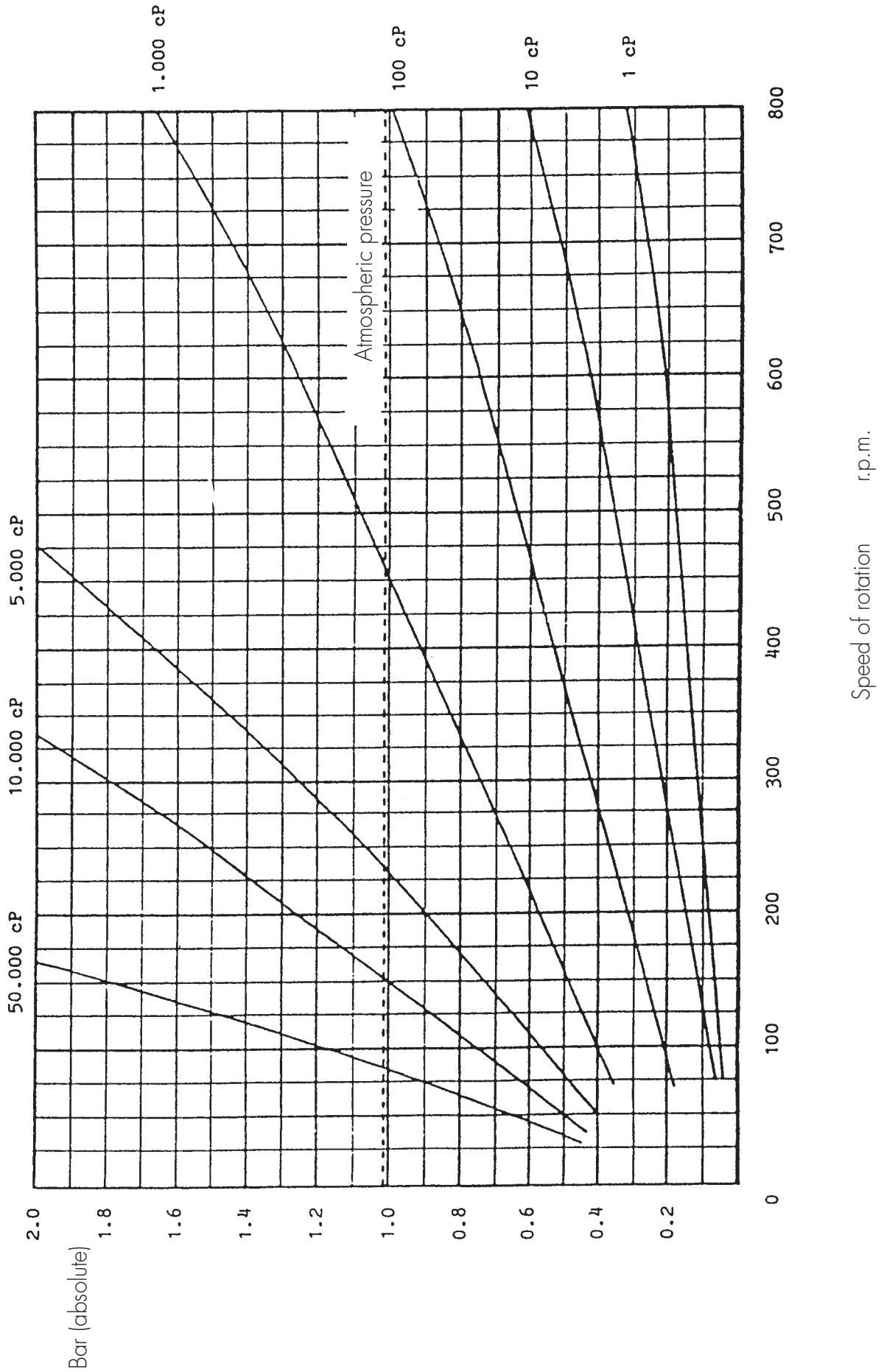

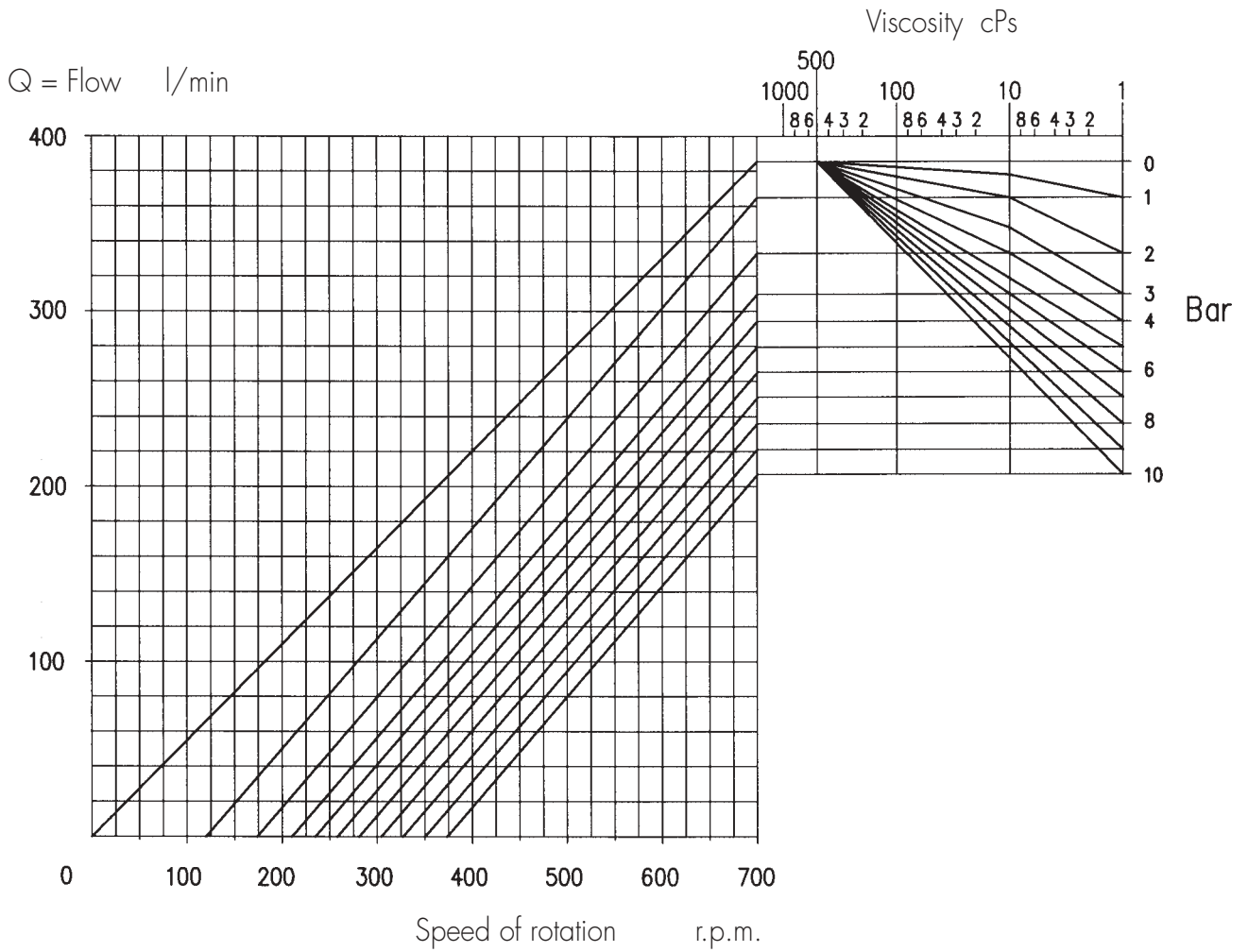

Kw = Absorbed power

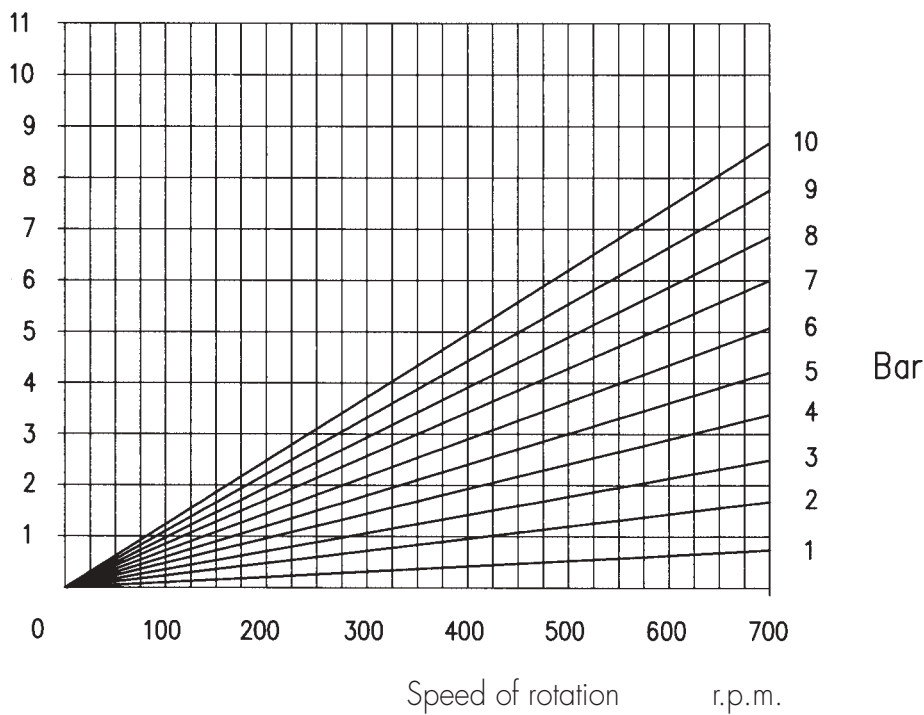

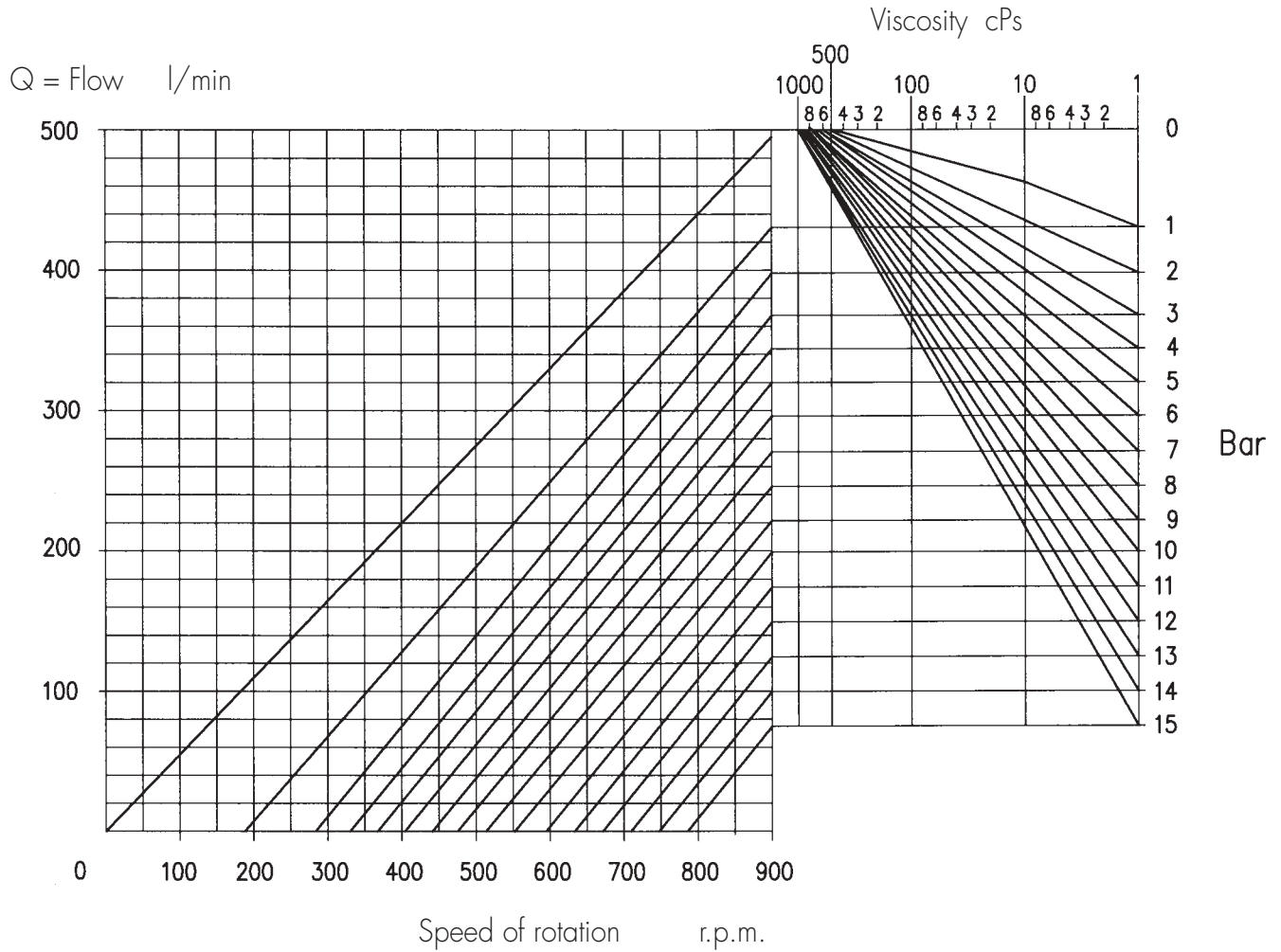

Kw = Absorbed power

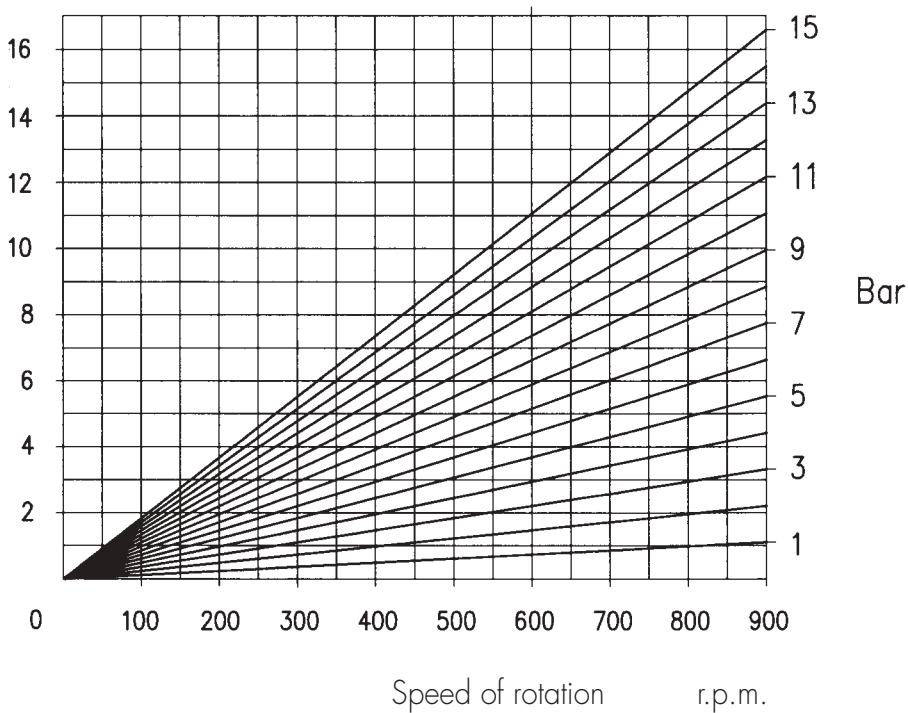

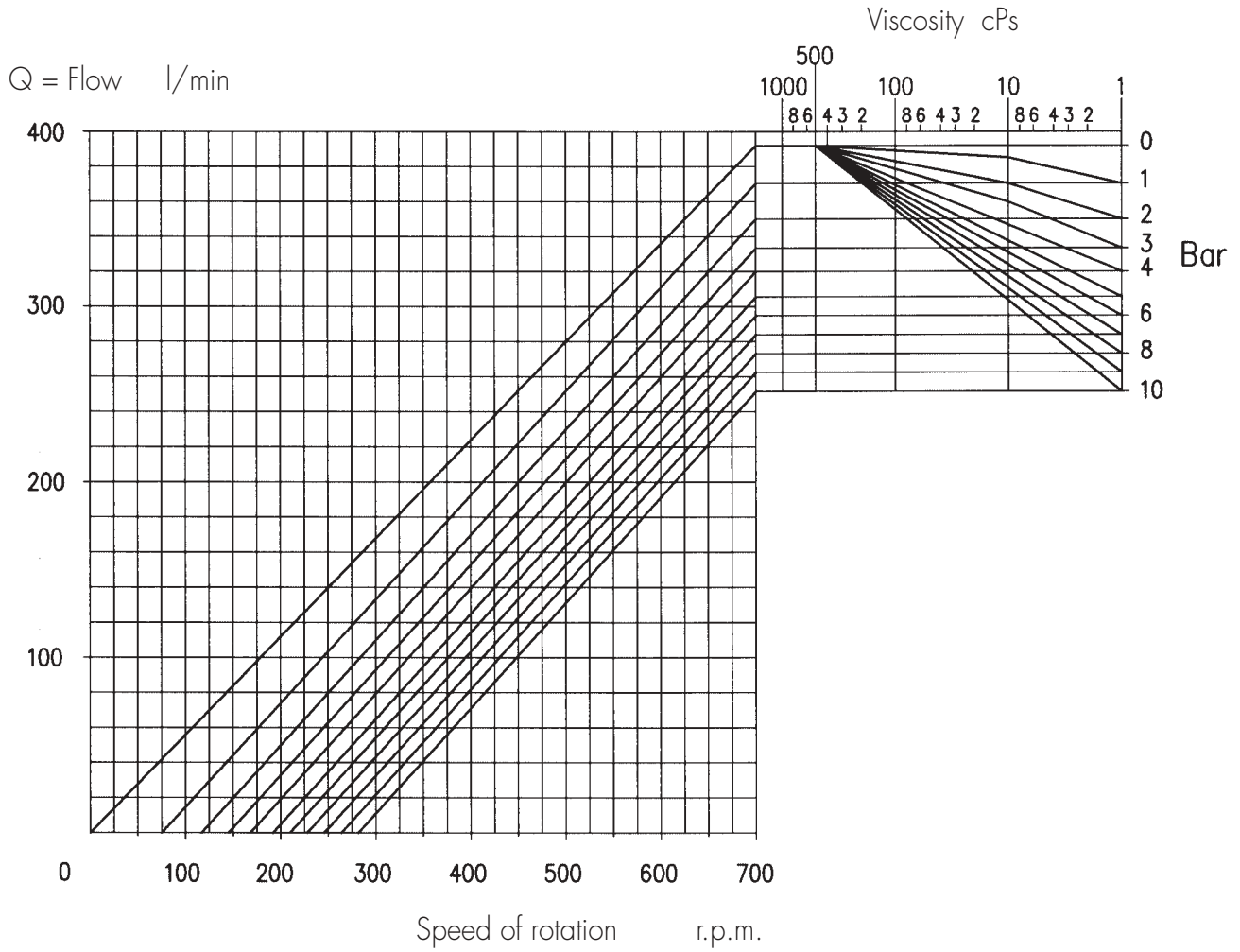

Kw = Absorbed power

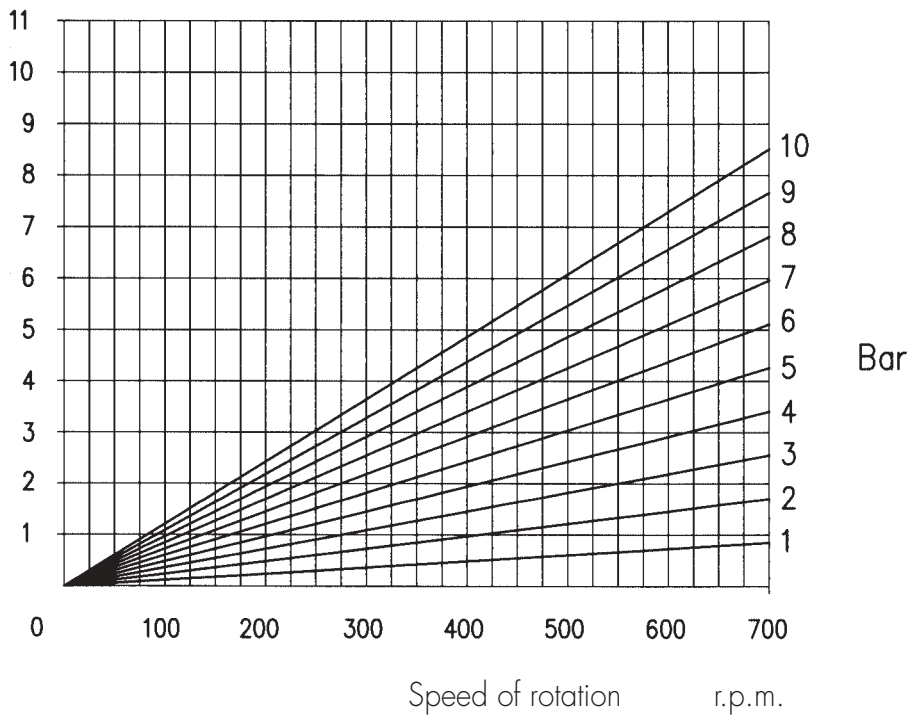

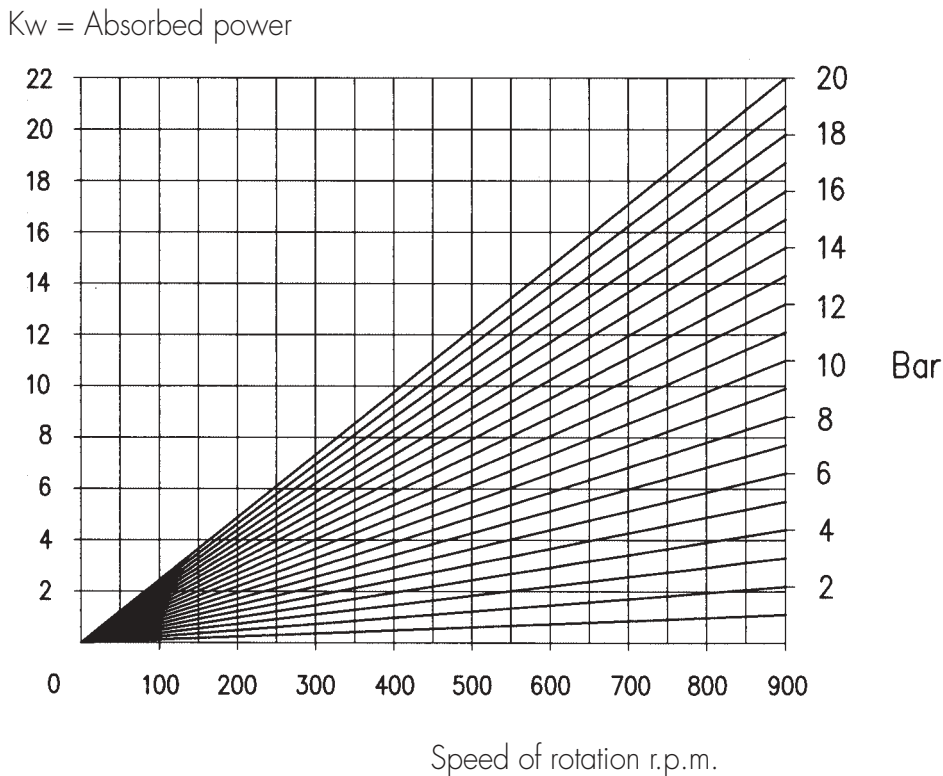
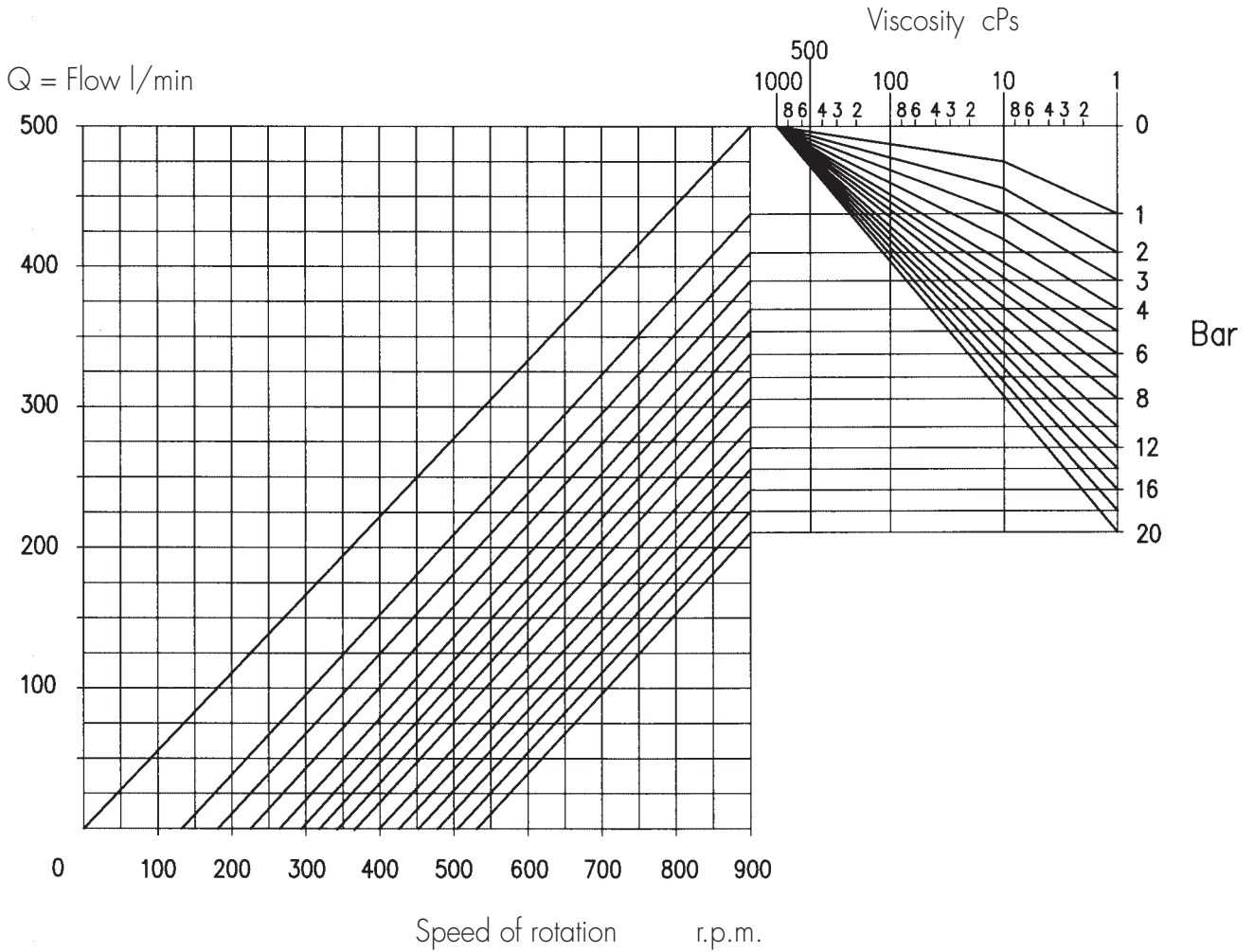



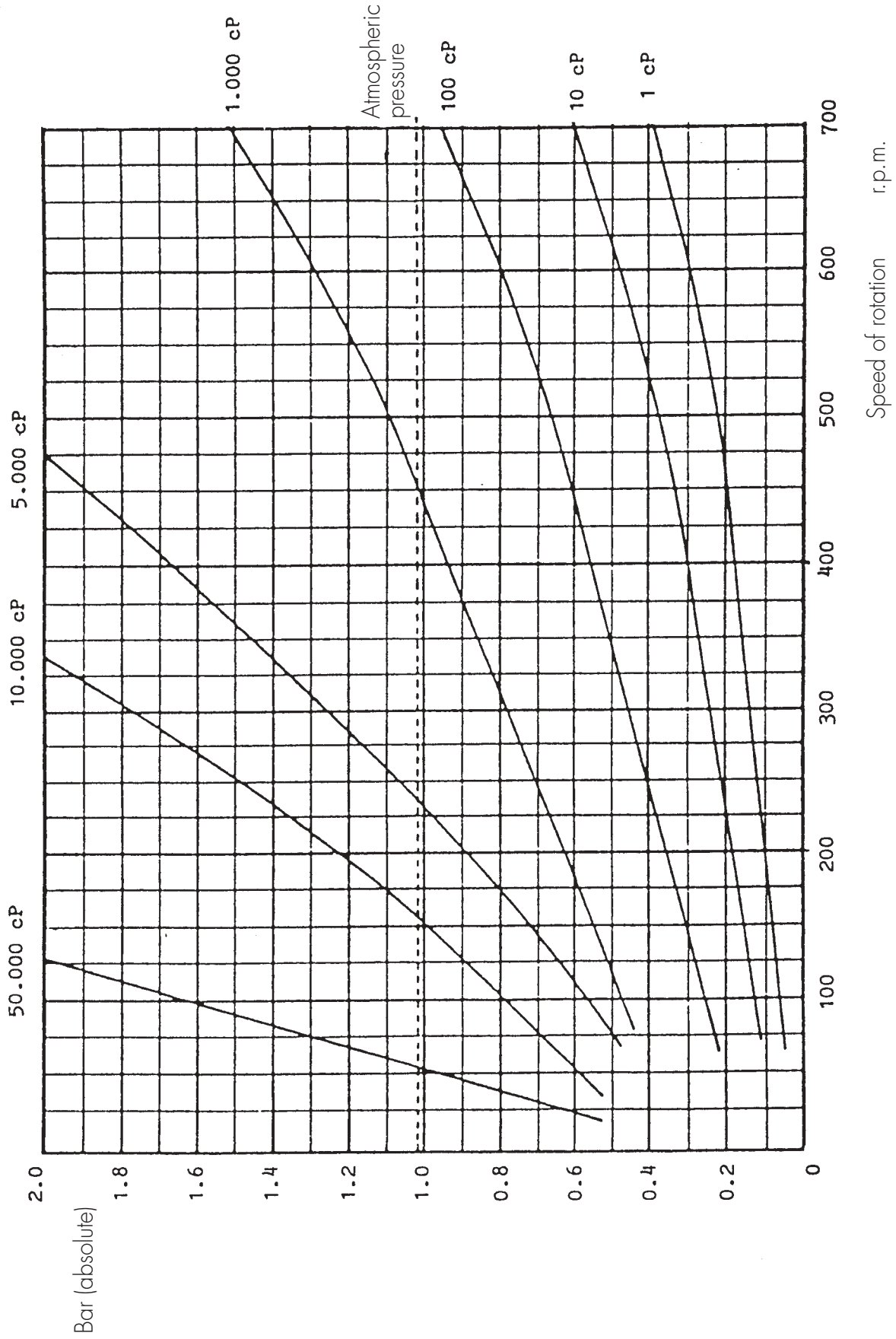

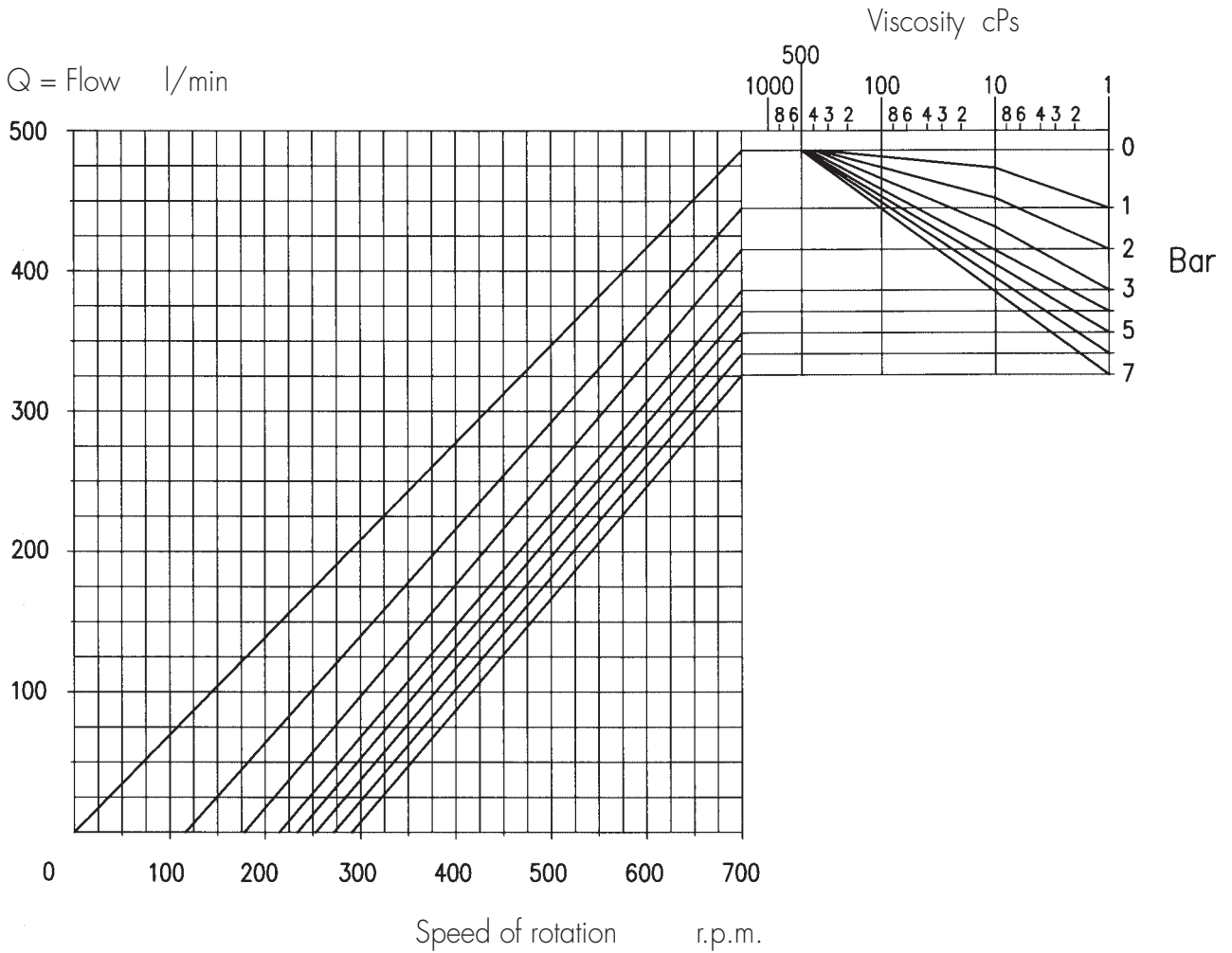

Kw = Absorbed power

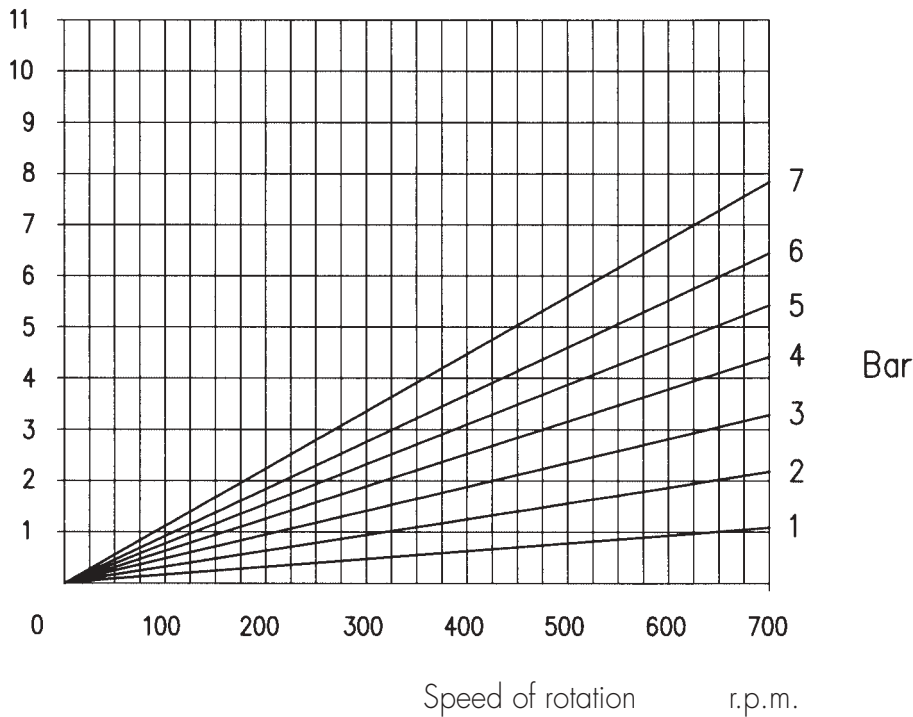

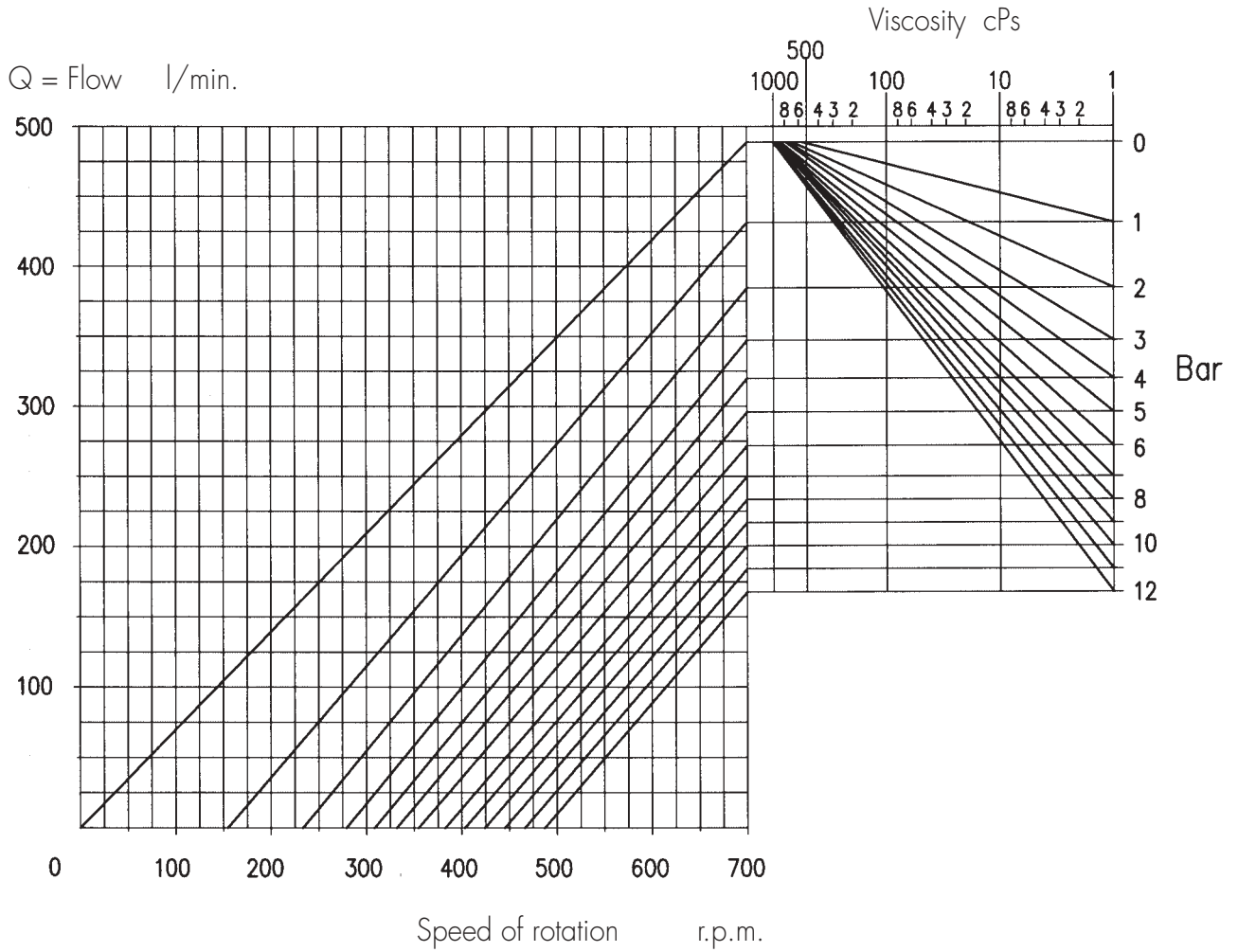

Kw = Absorbed power

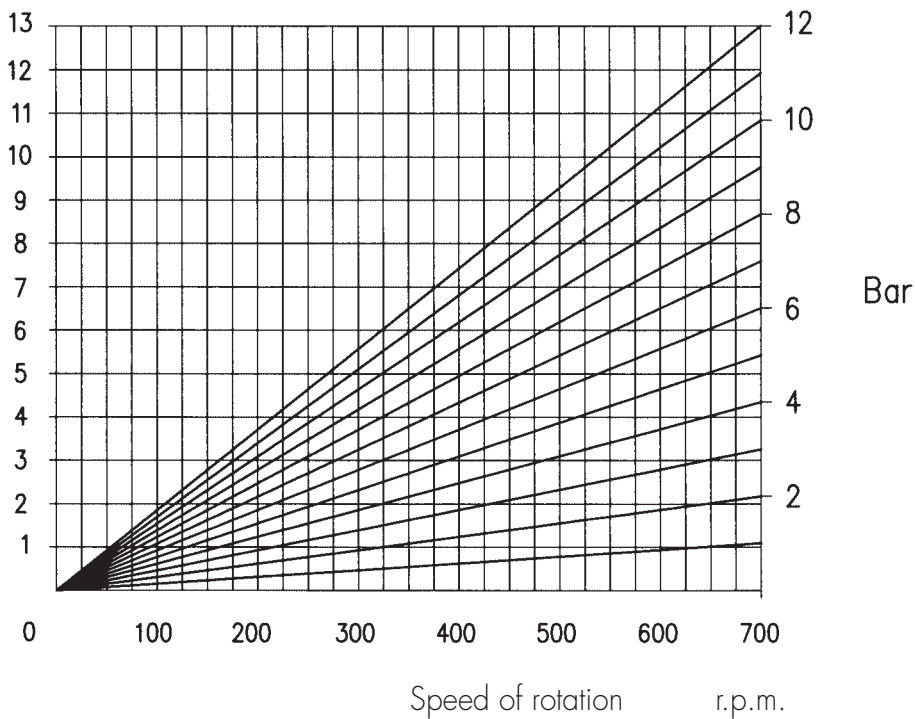

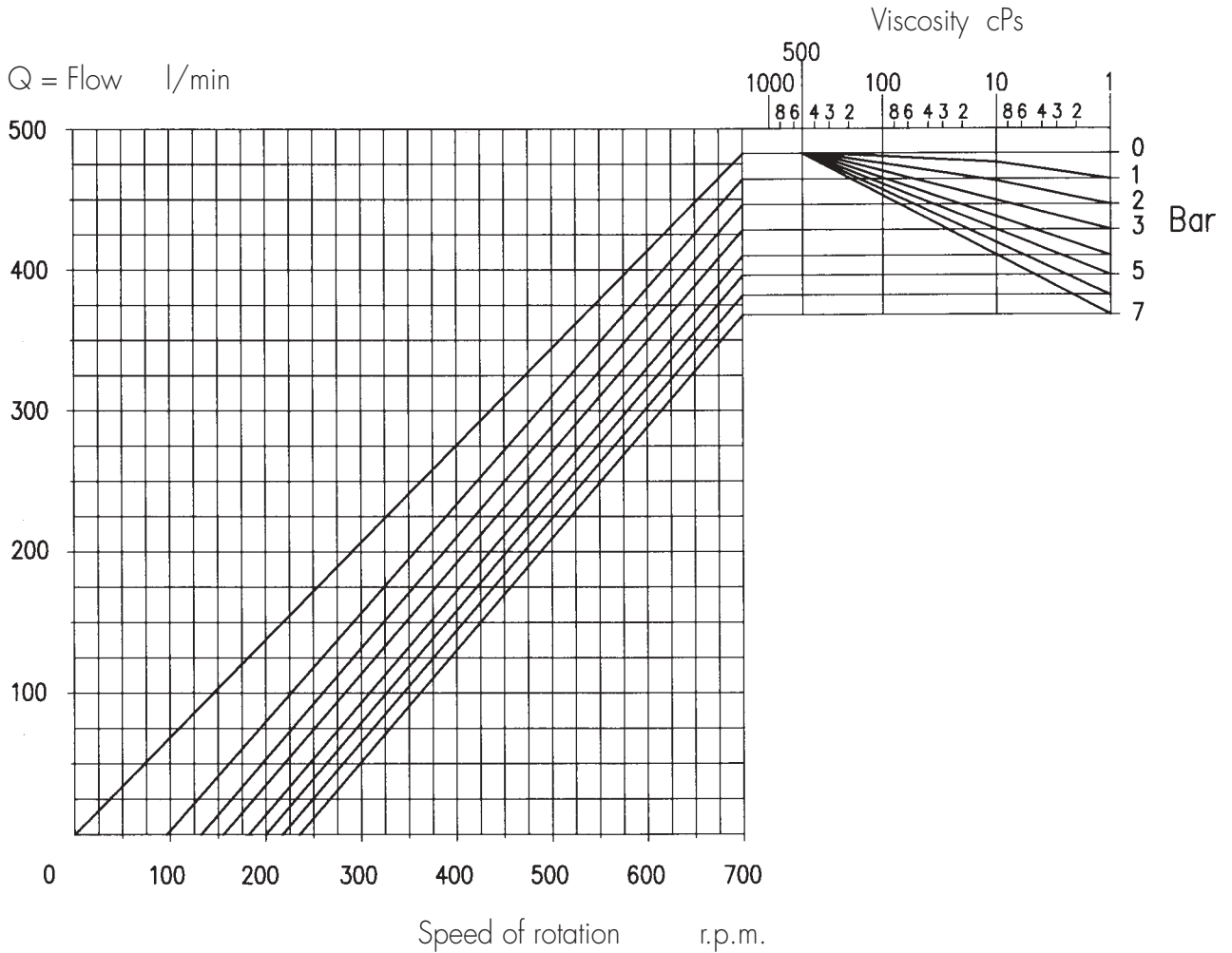

Kw = Absorbed power

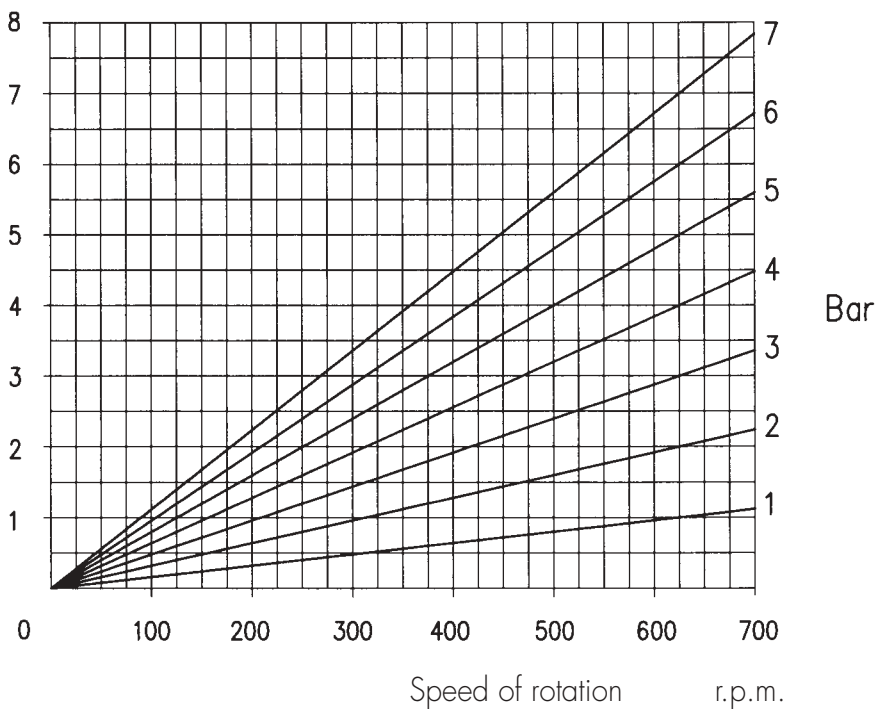

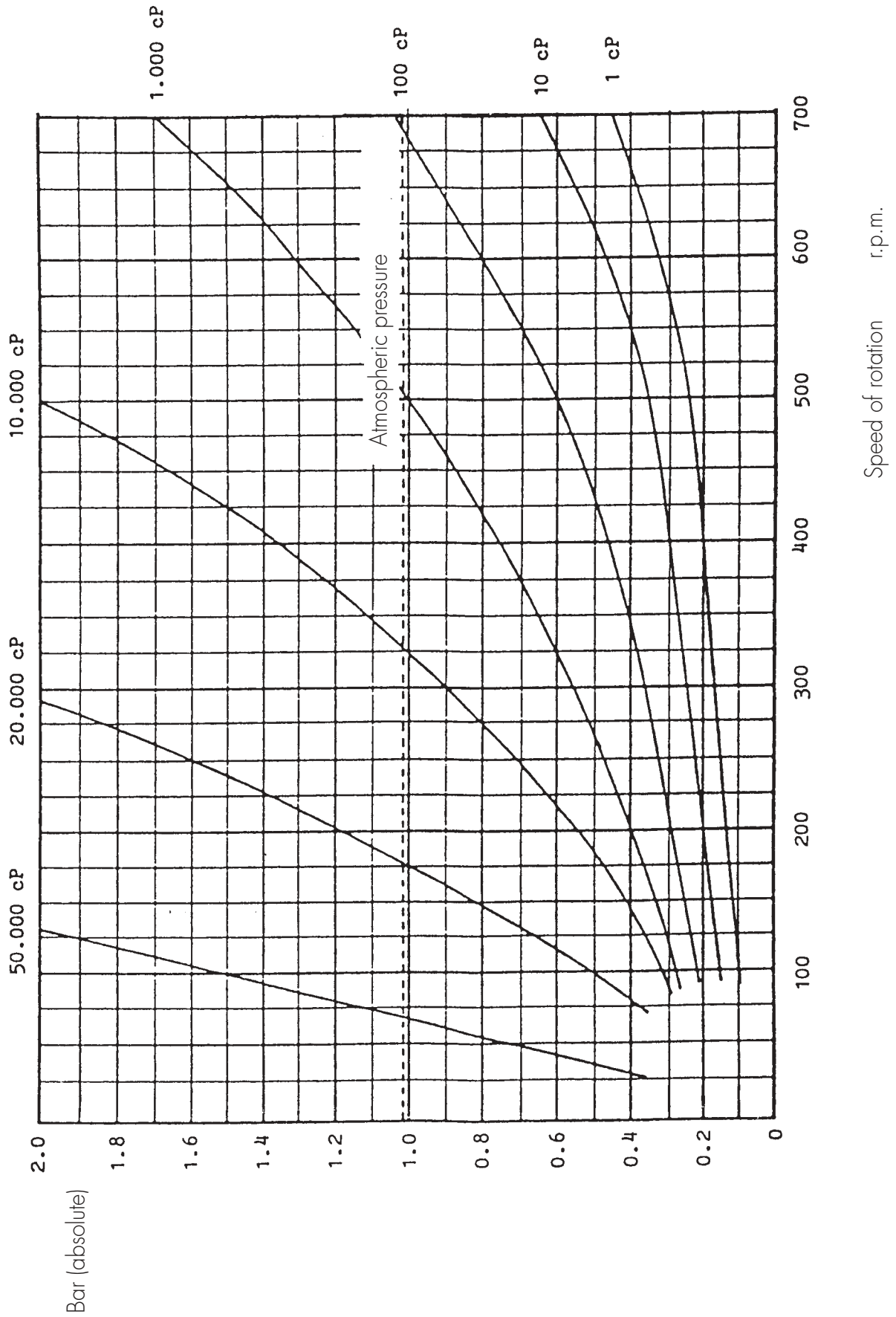

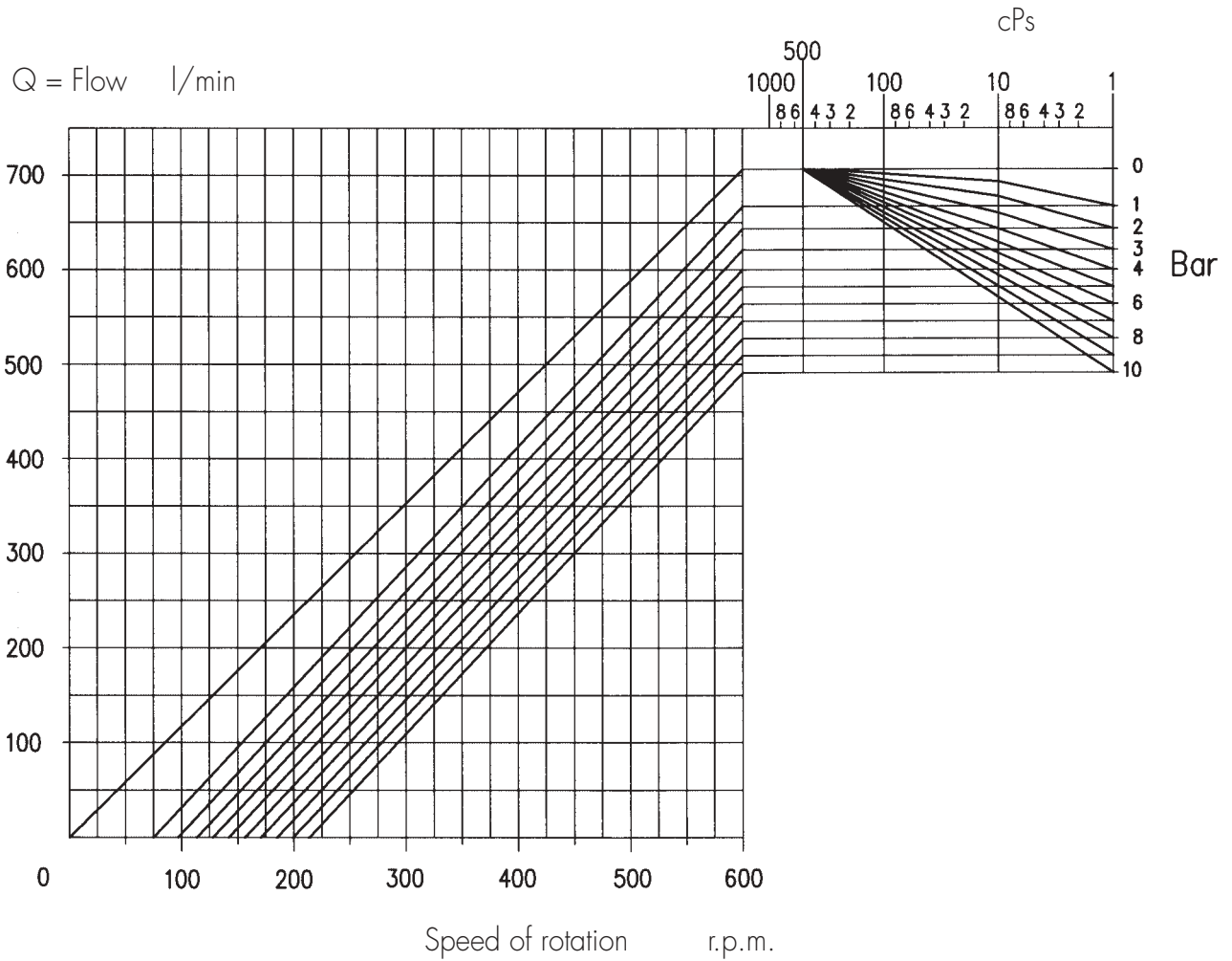

Kw = Absorbed power

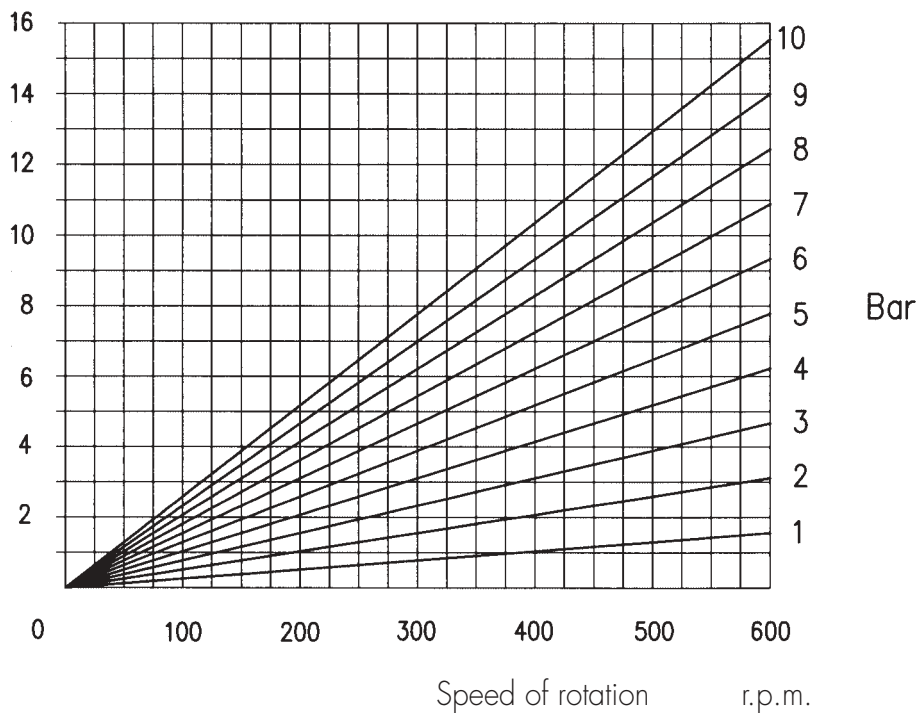

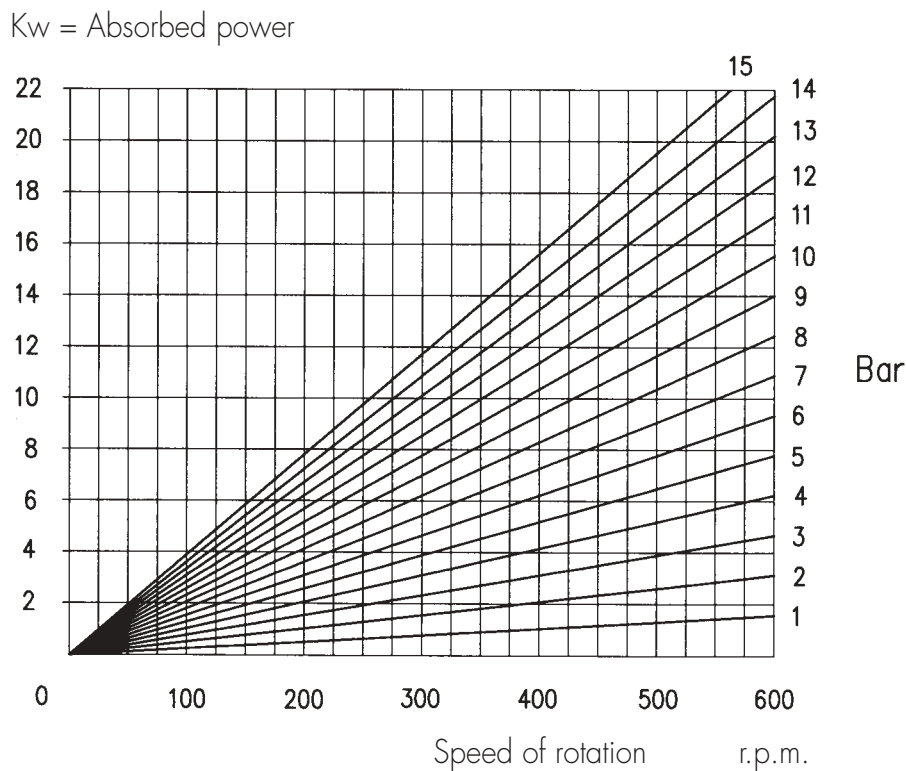
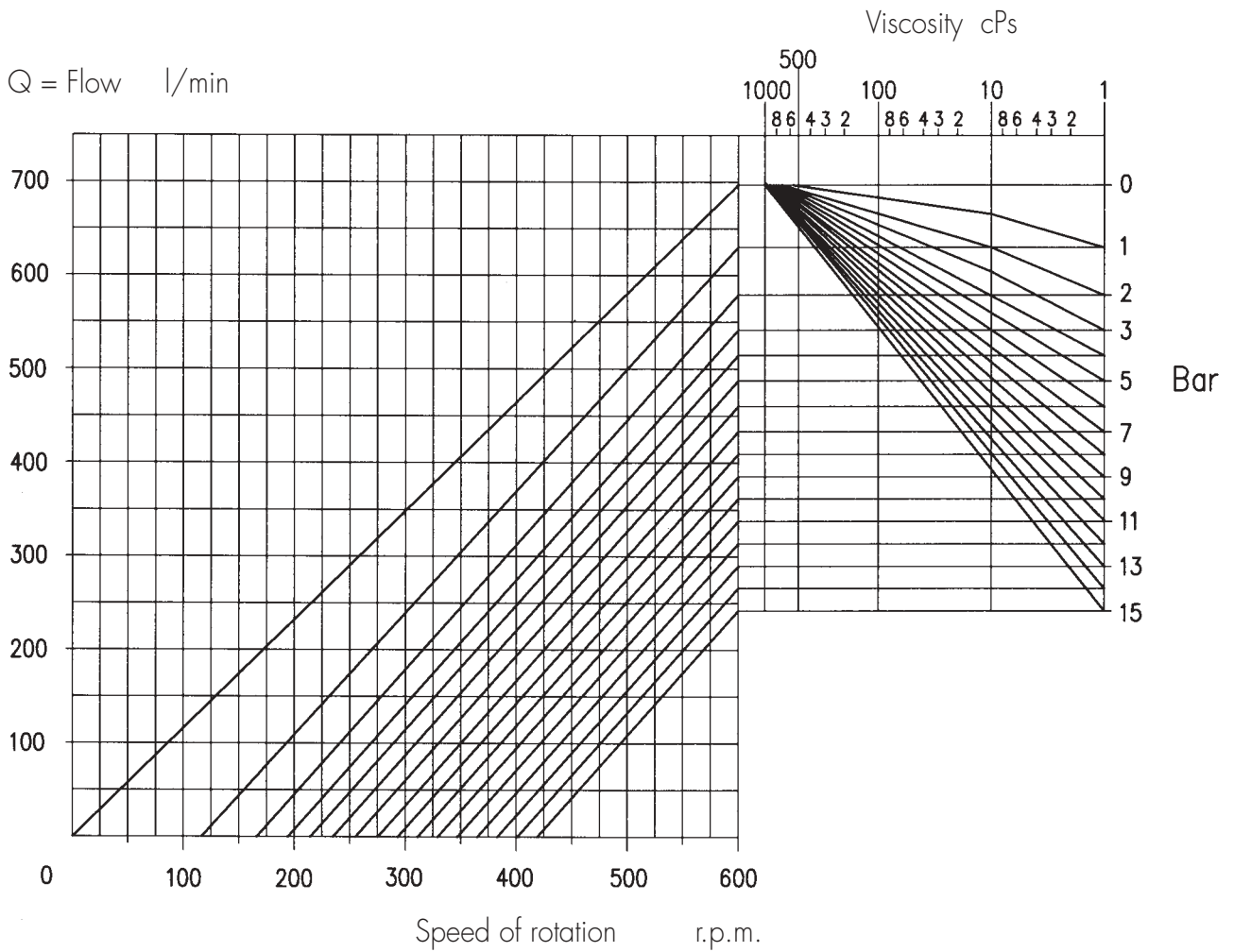

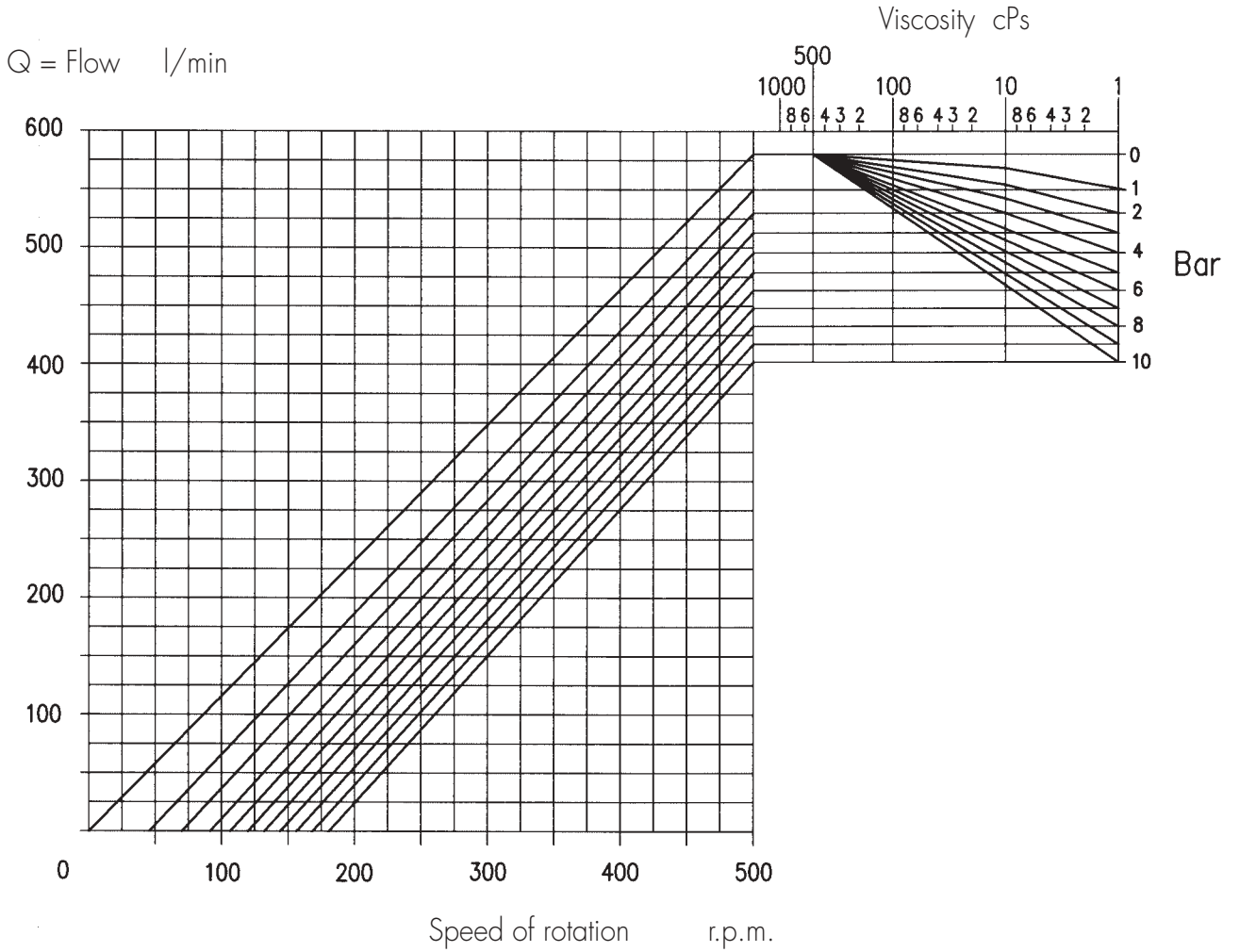

Kw = Absorbed power

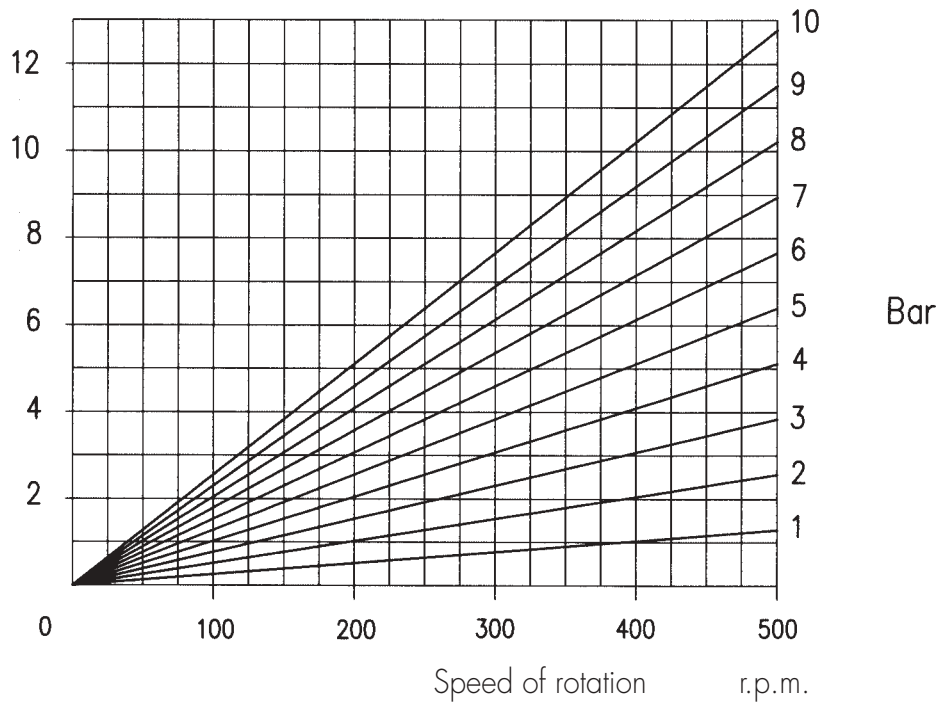



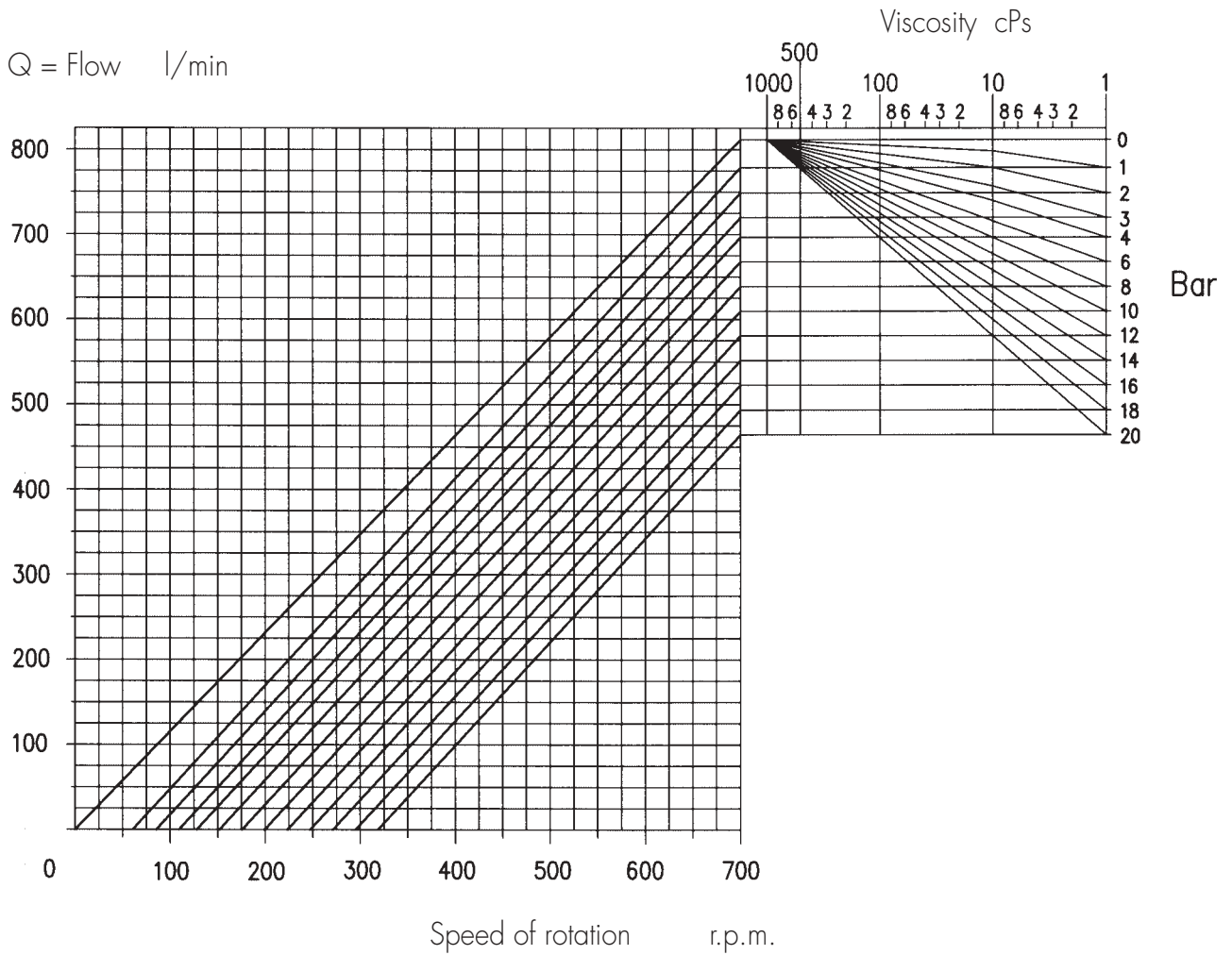

Kw = Absorbed power

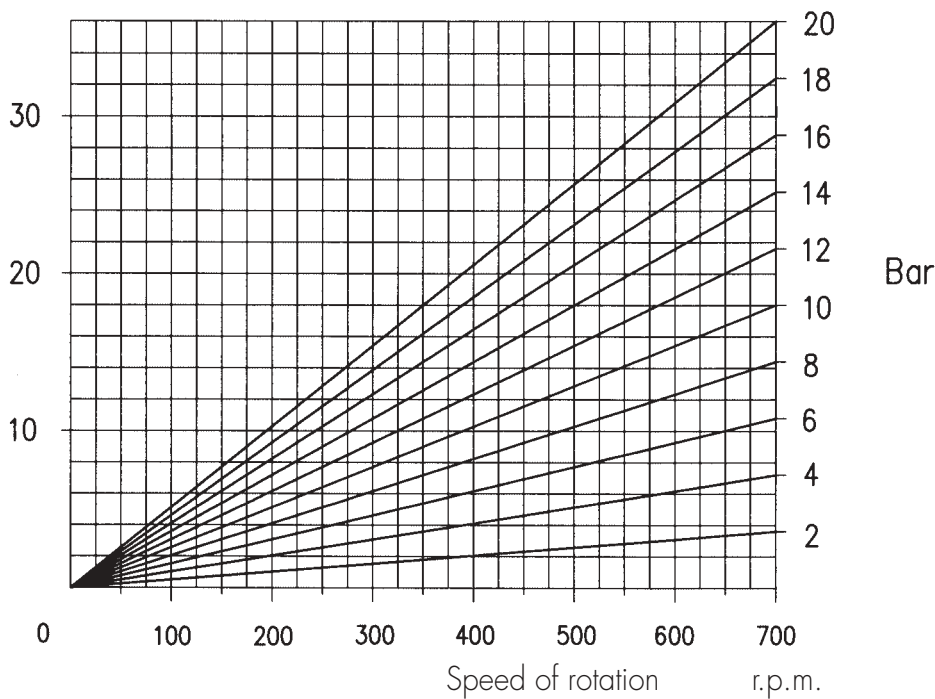

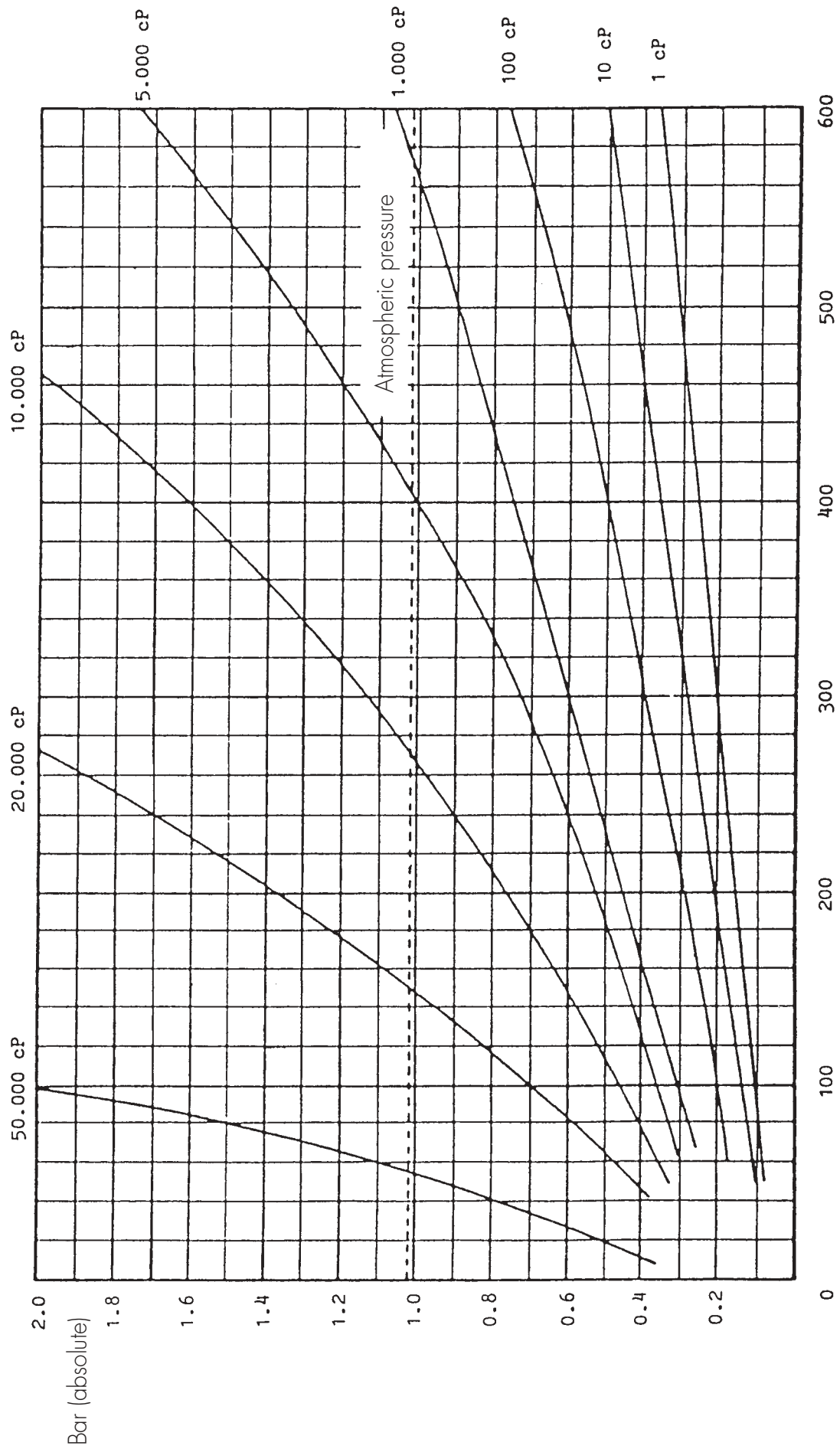

Speed of rotation r.p.m.

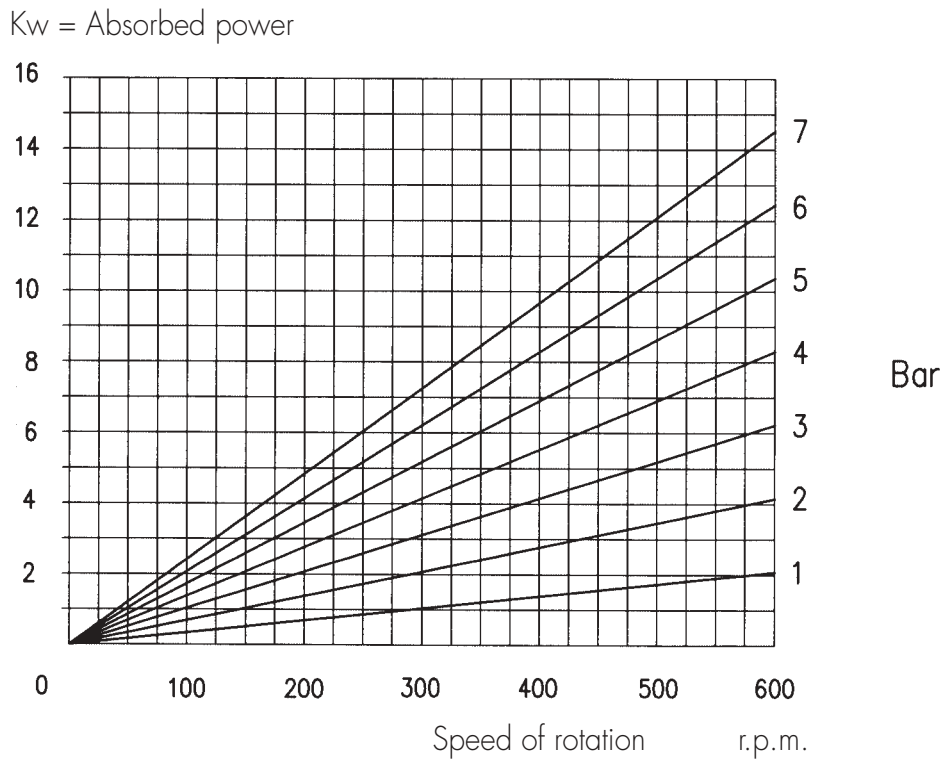
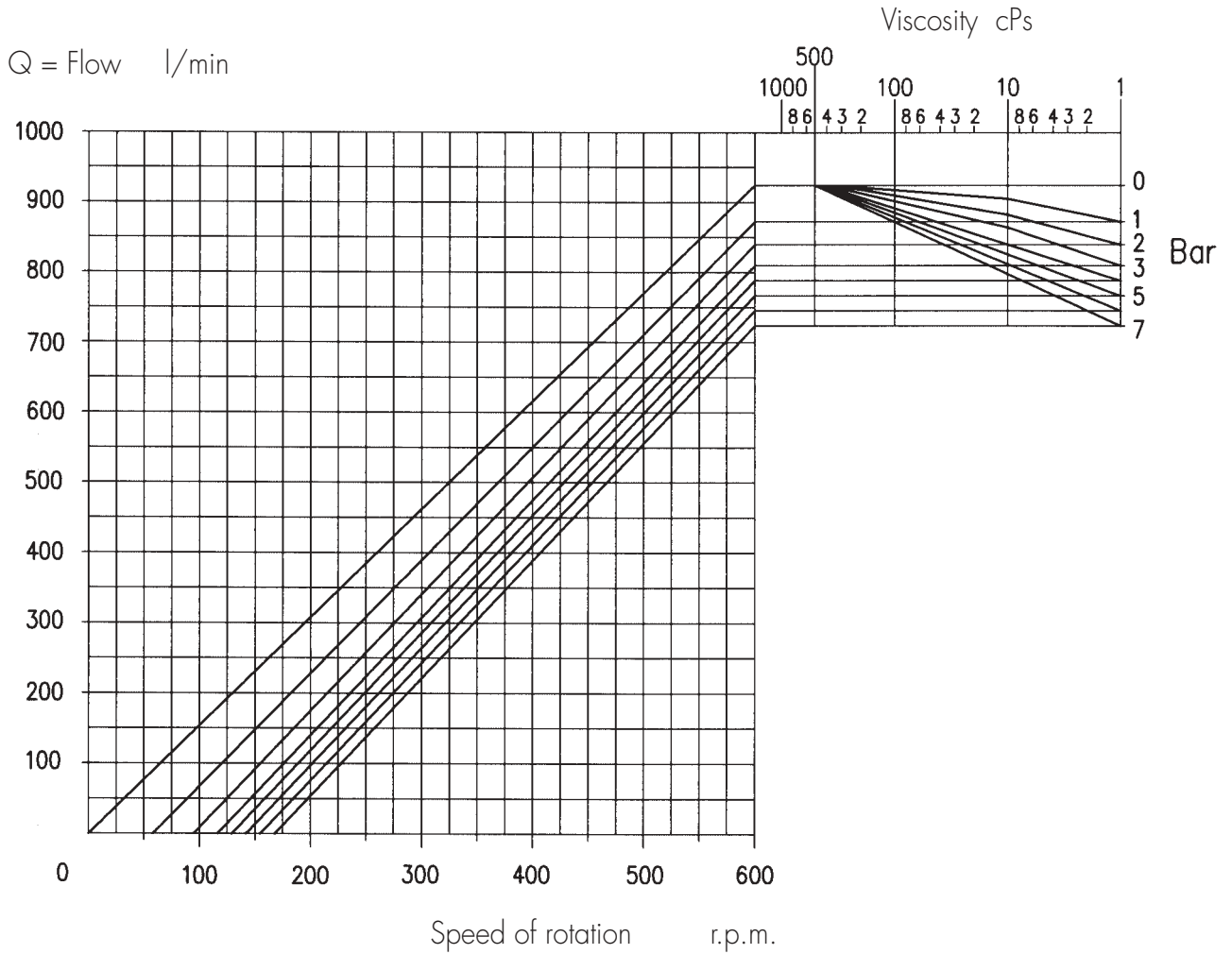

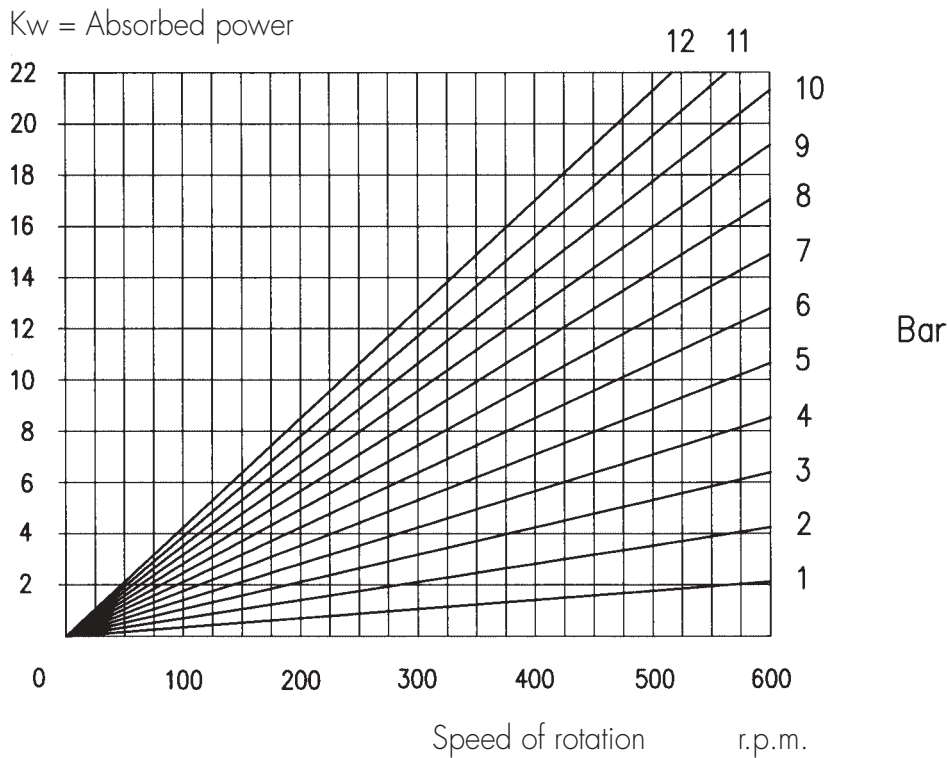
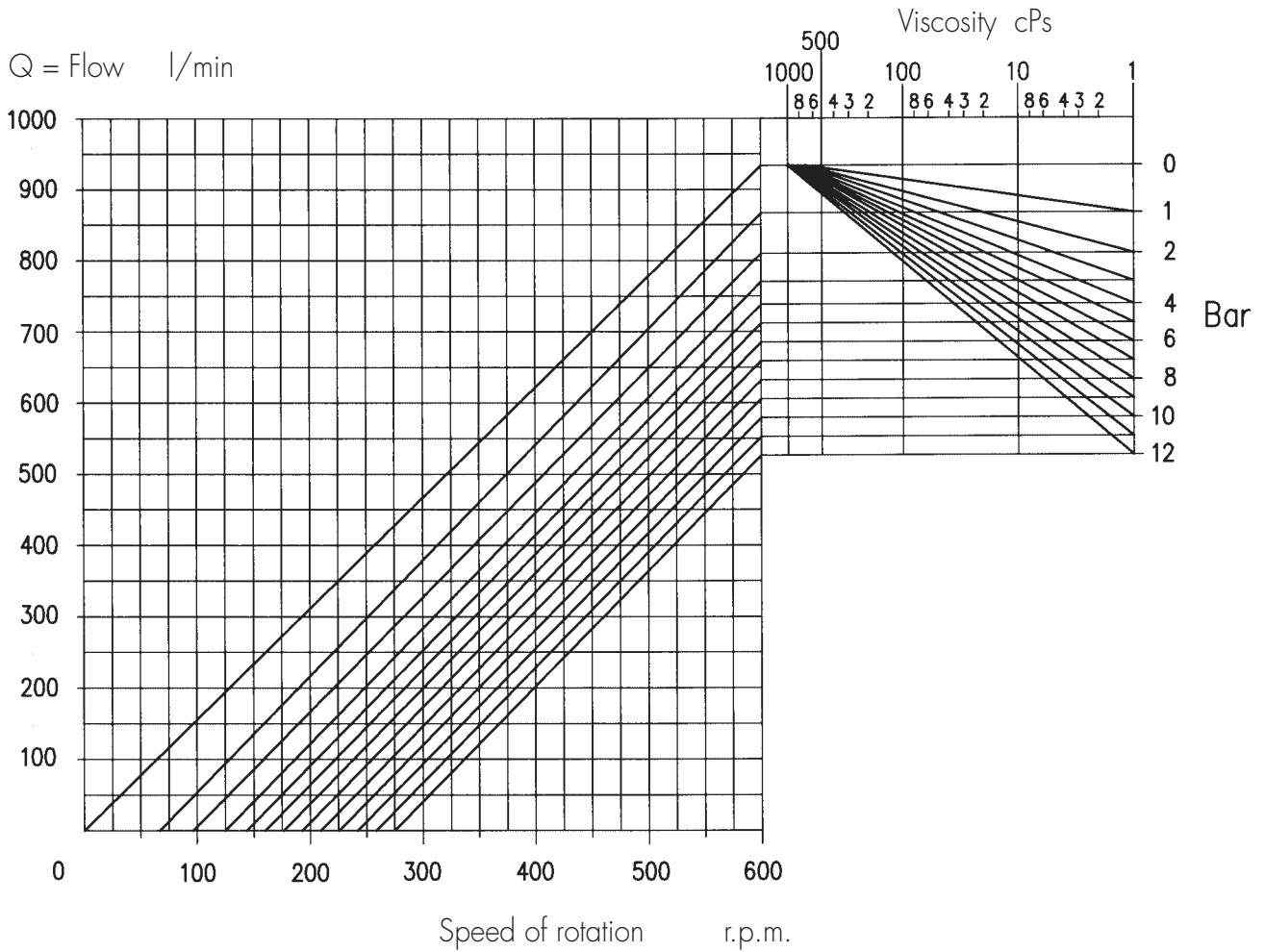

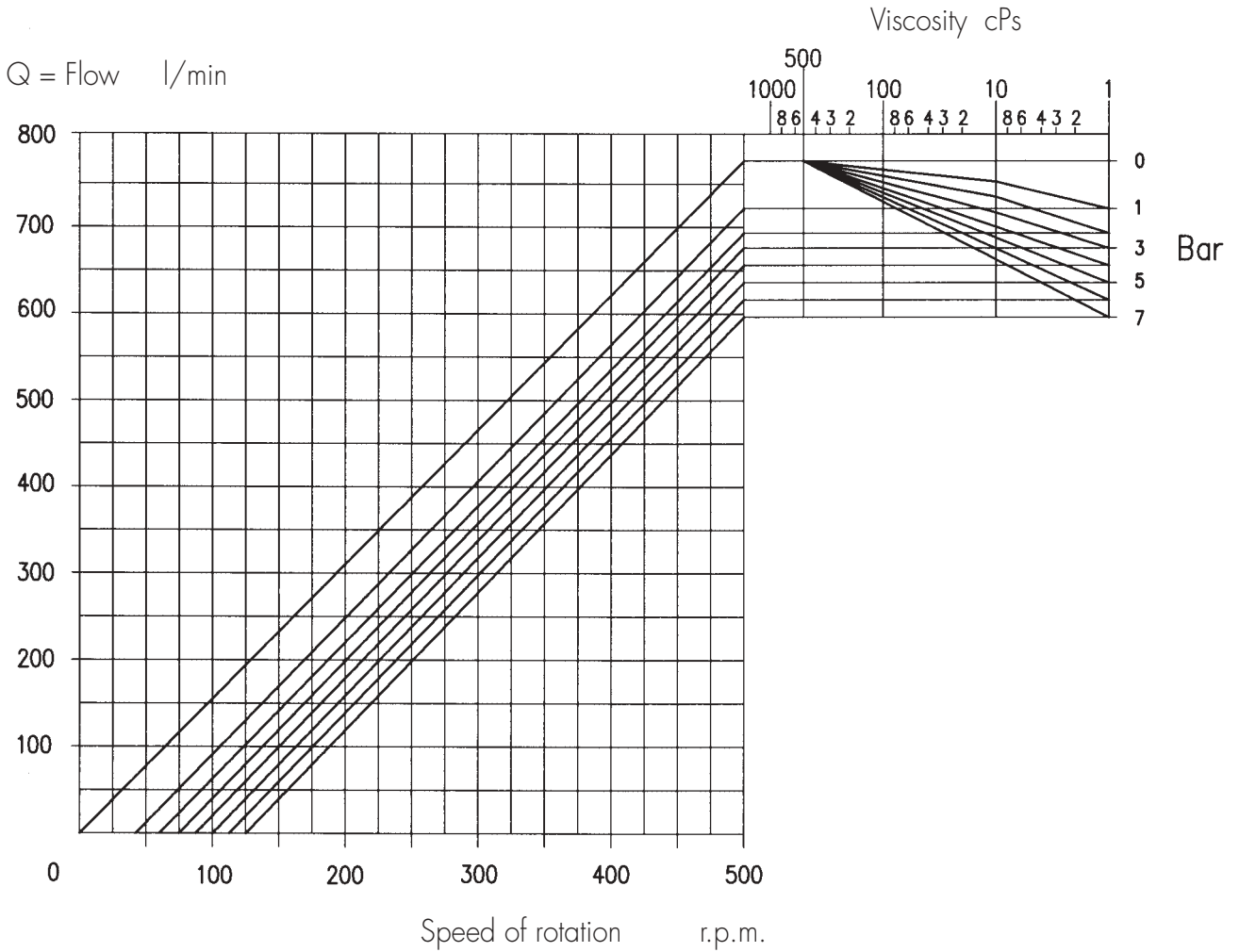

Kw = Absorbed power

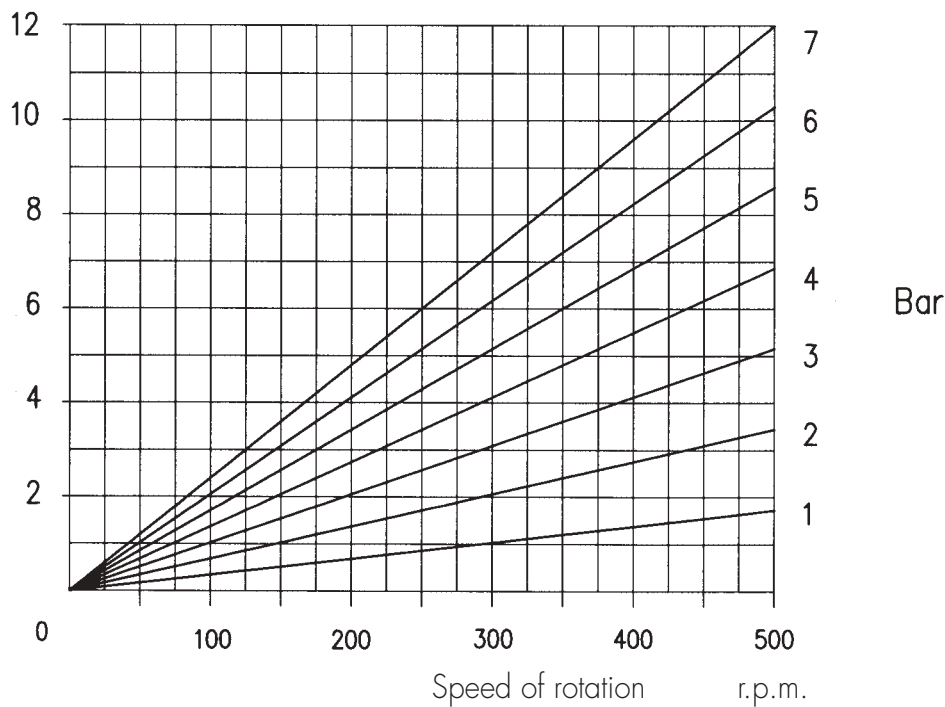

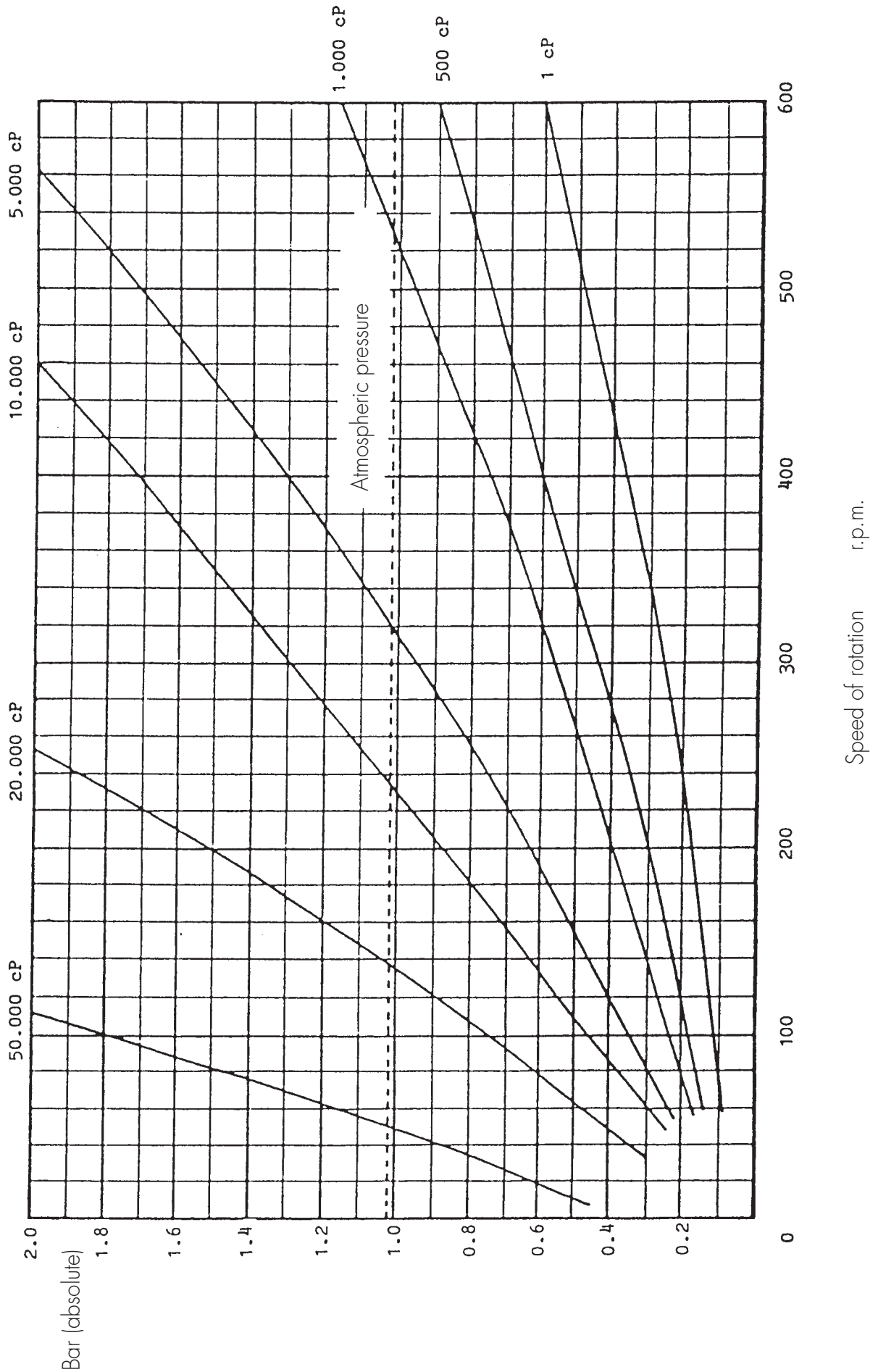

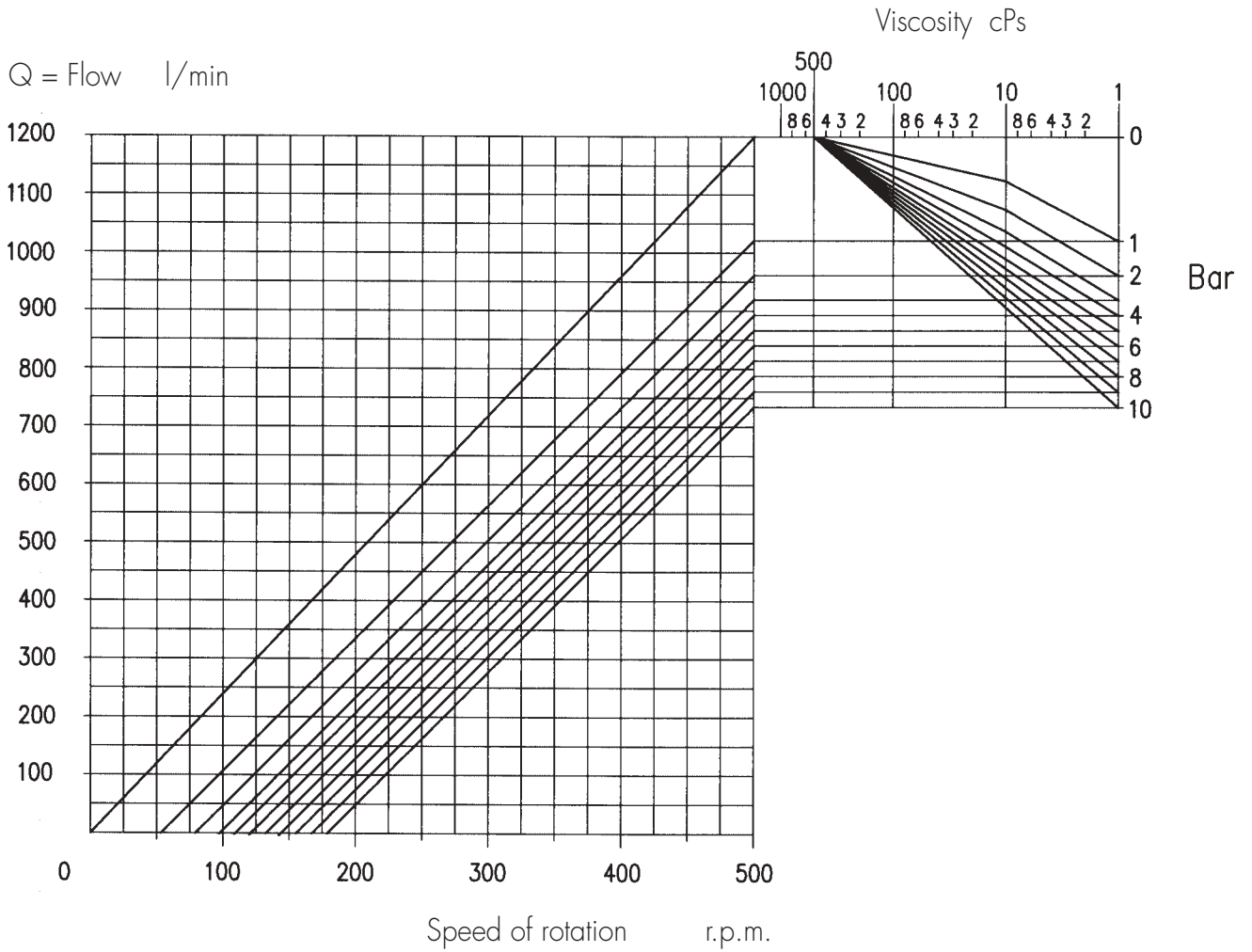

Kw = Absorbed power

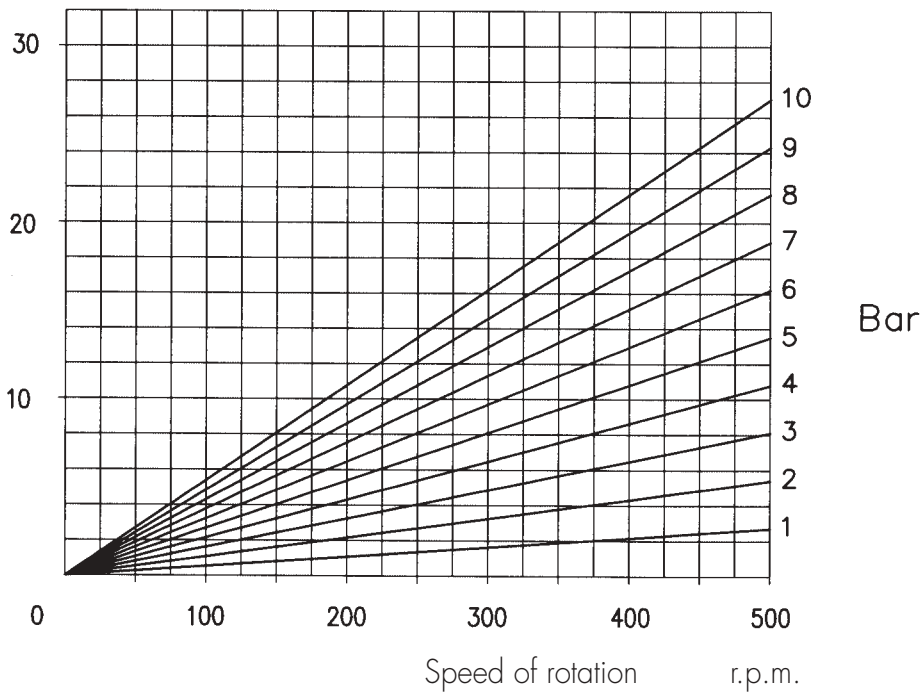

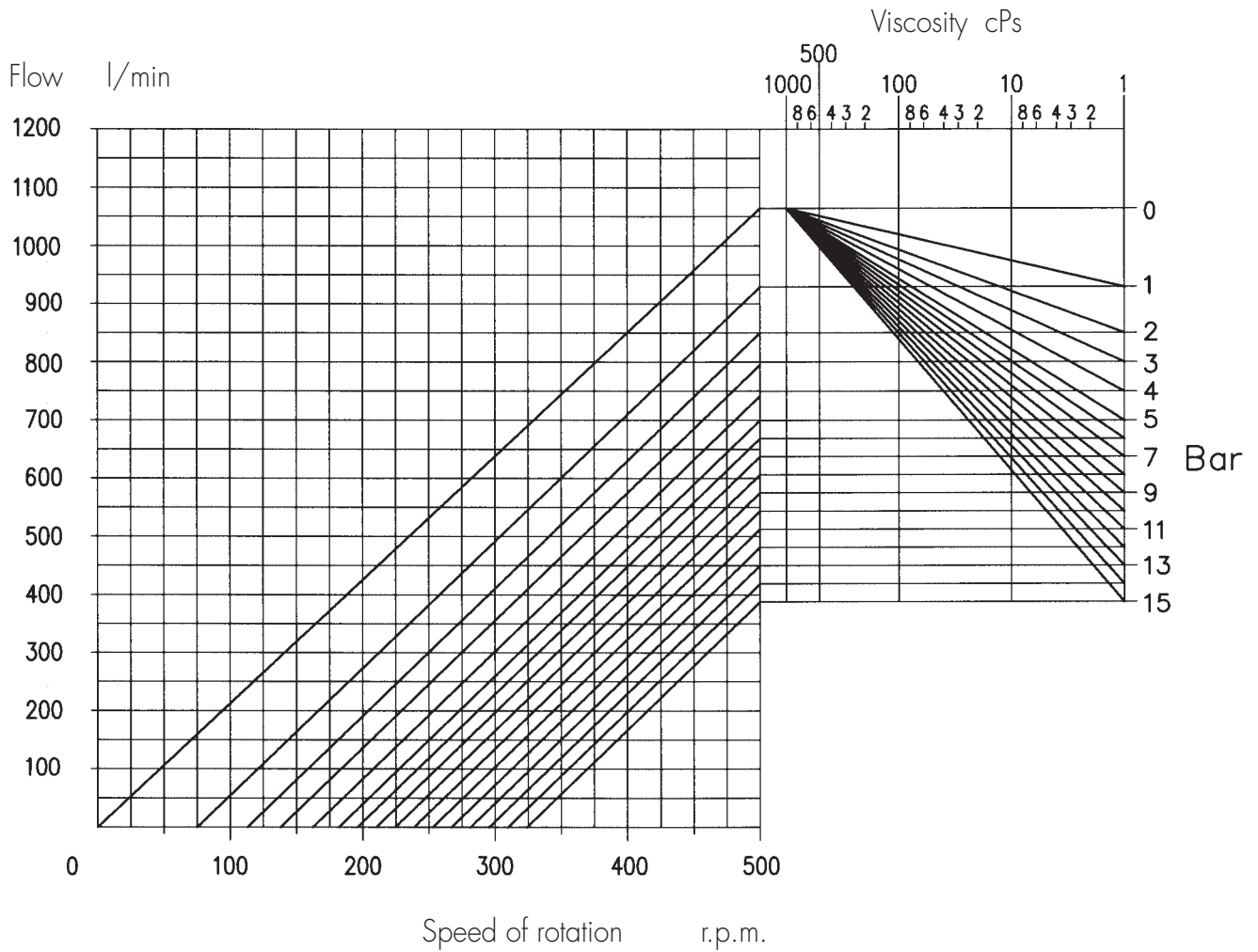

Kw = Absorbed power

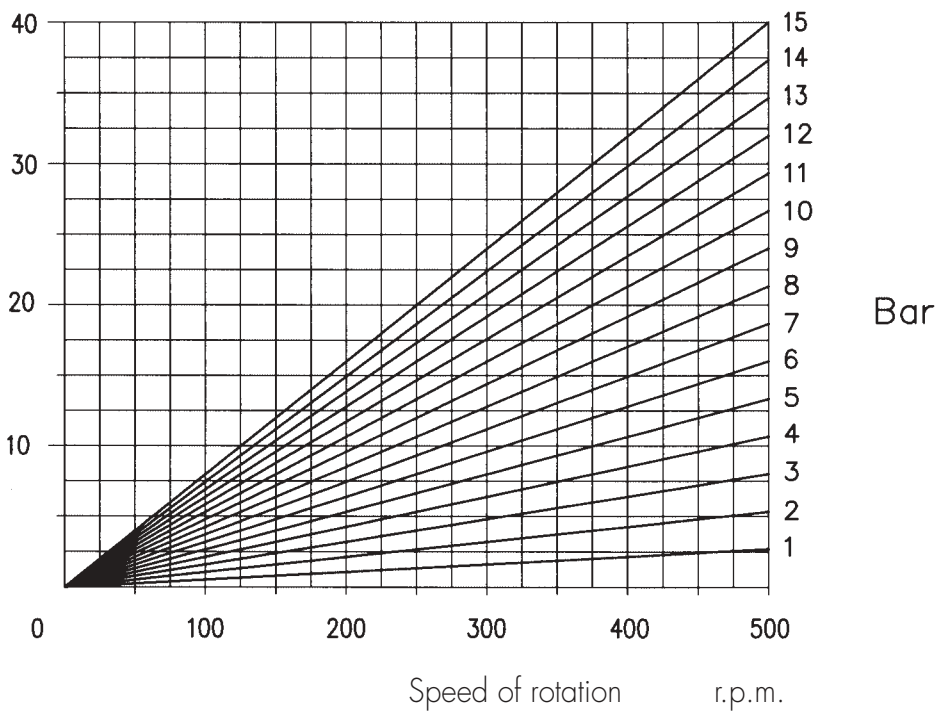



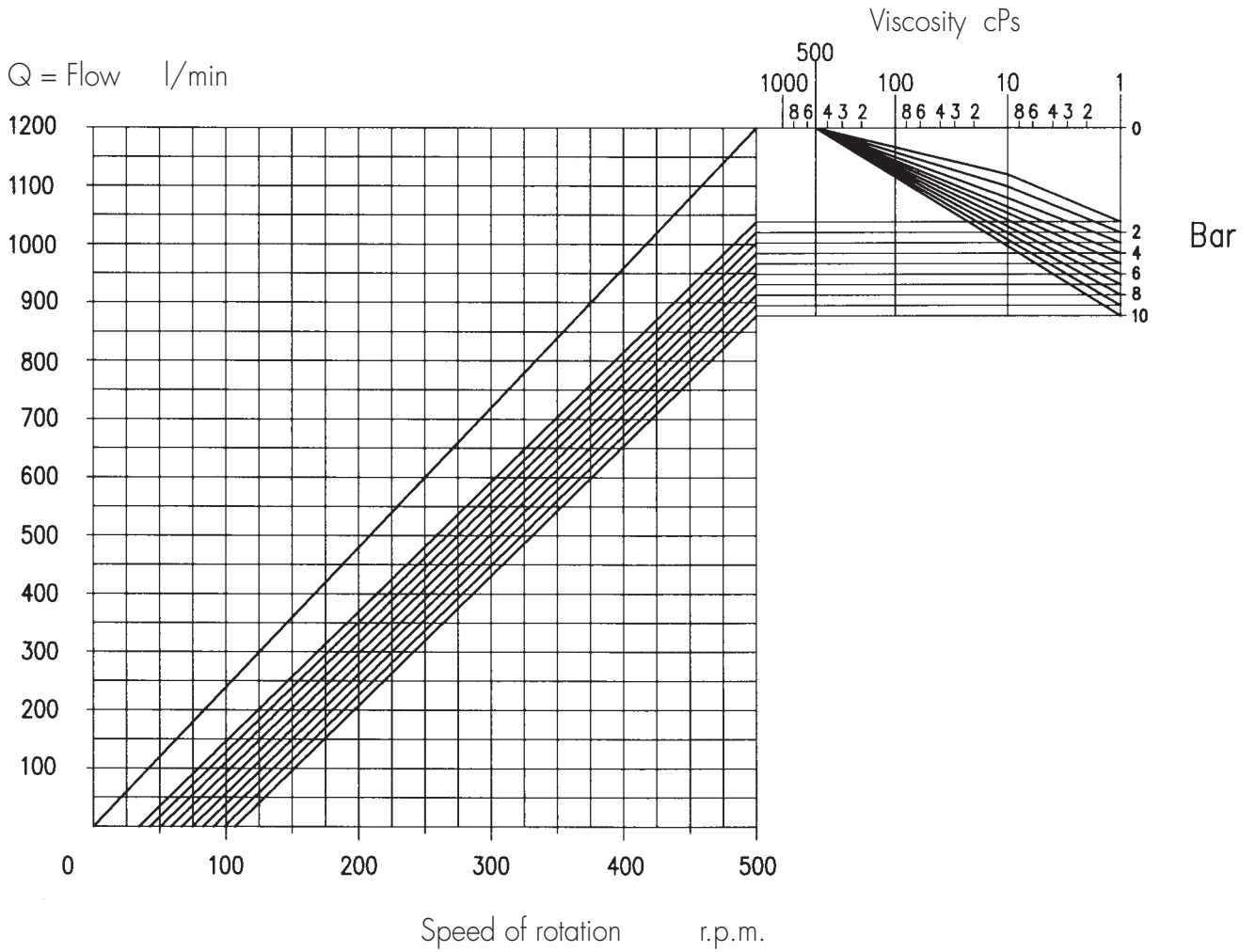

Kw = Absorbed power

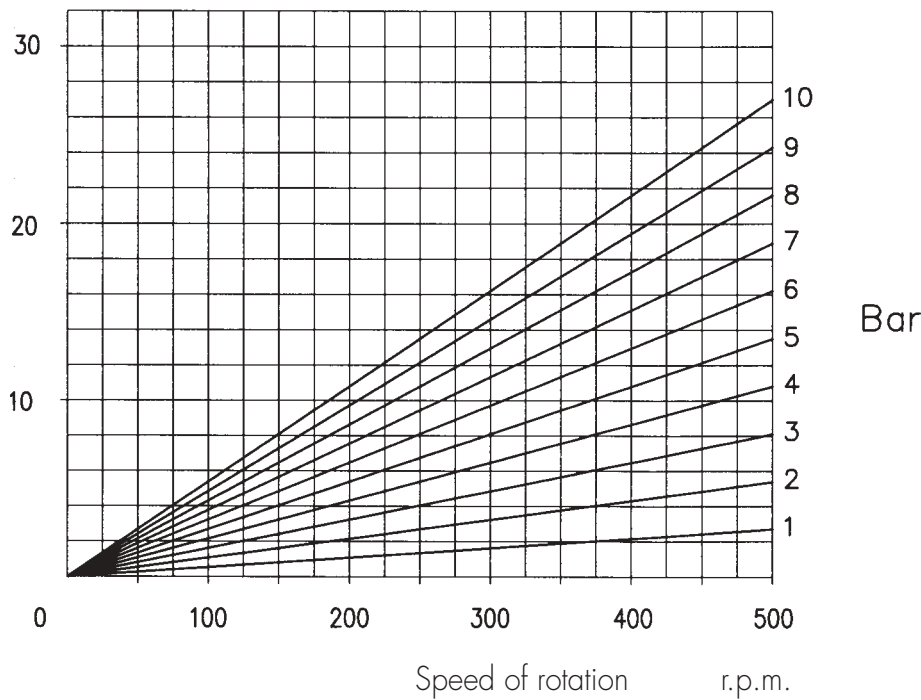

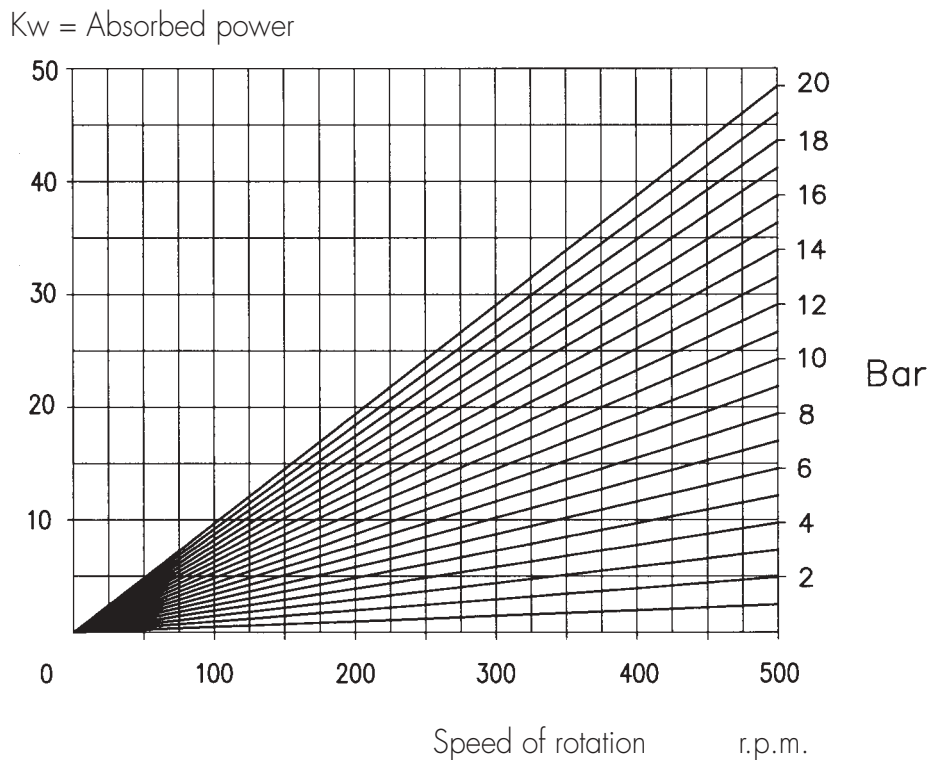
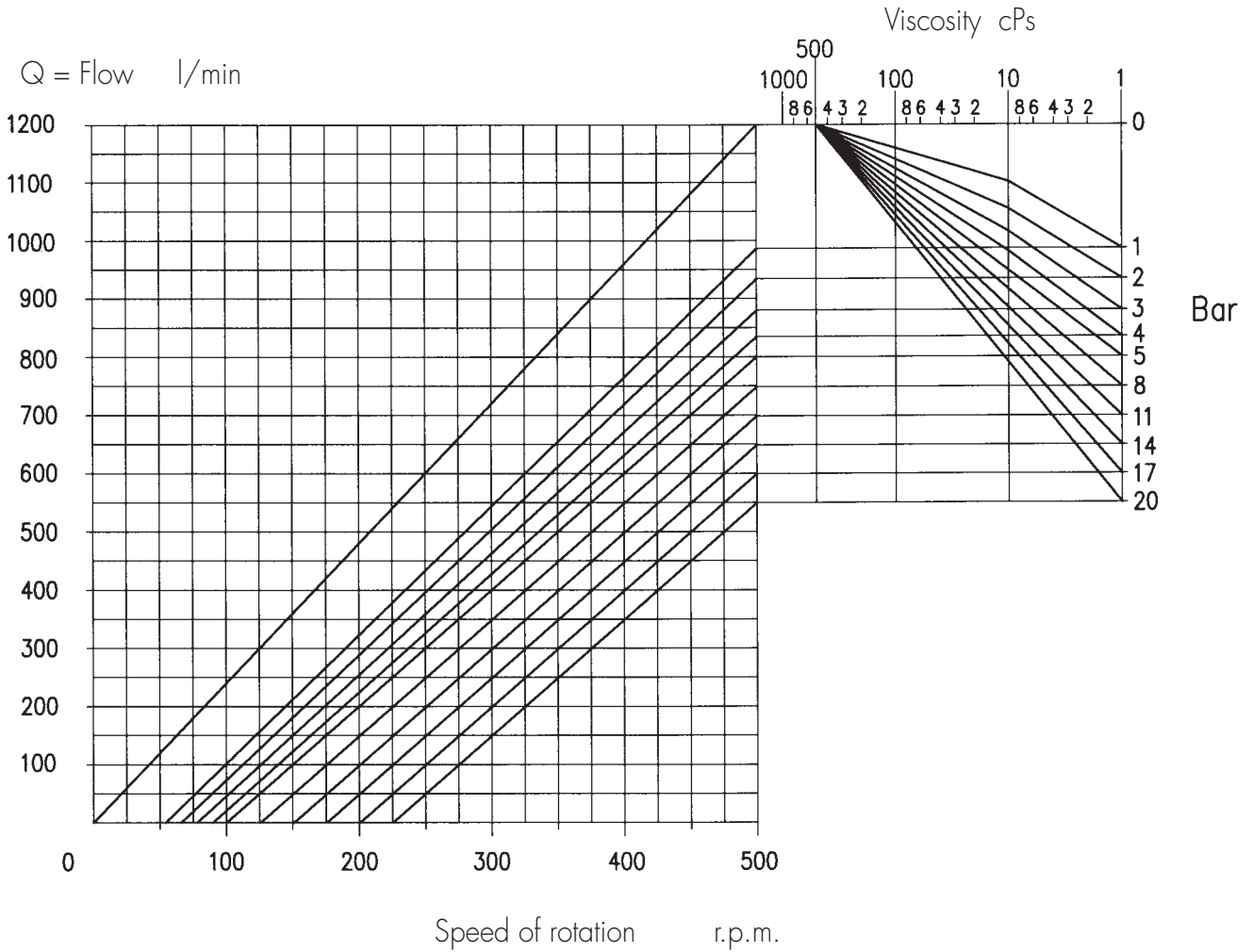

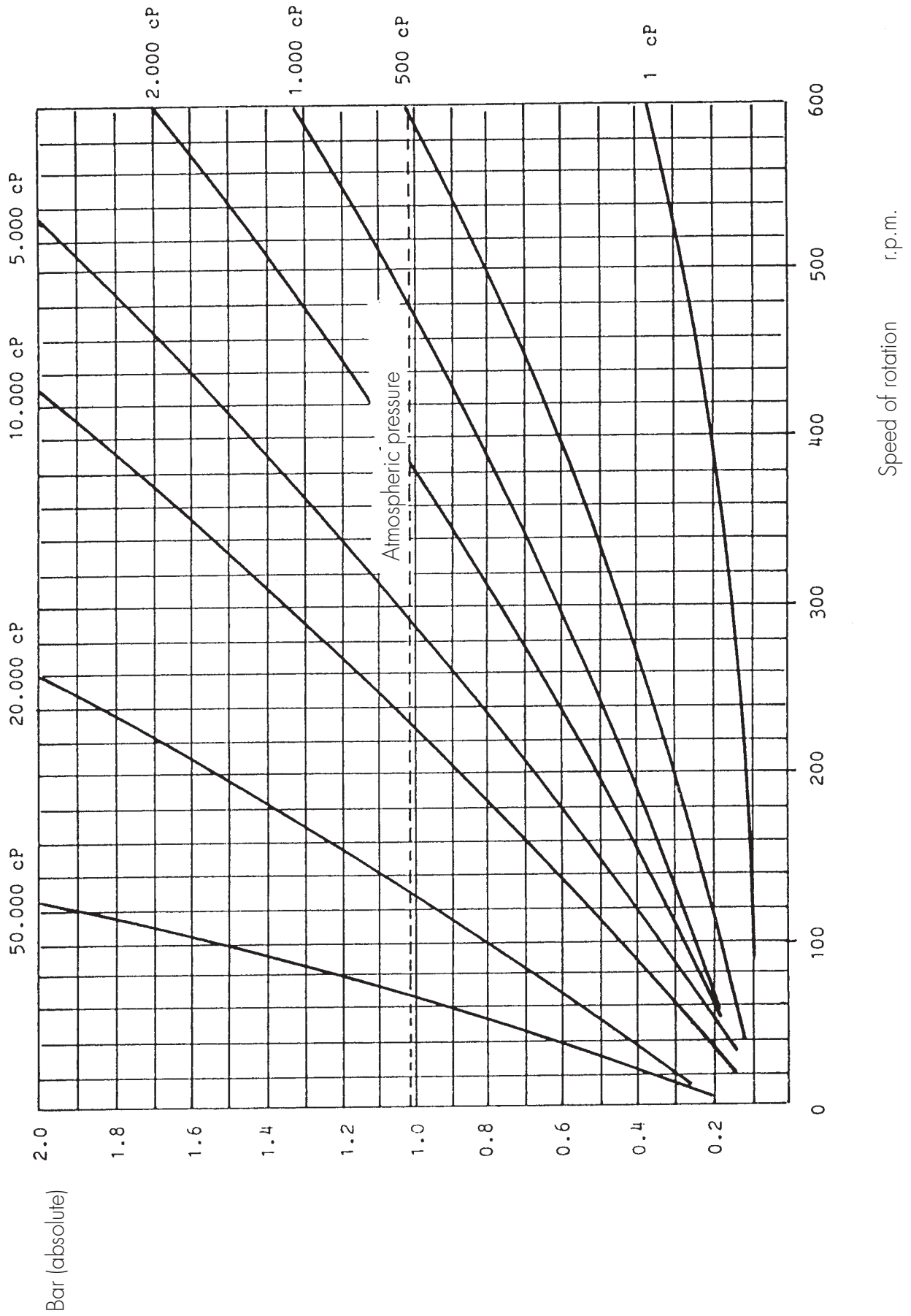

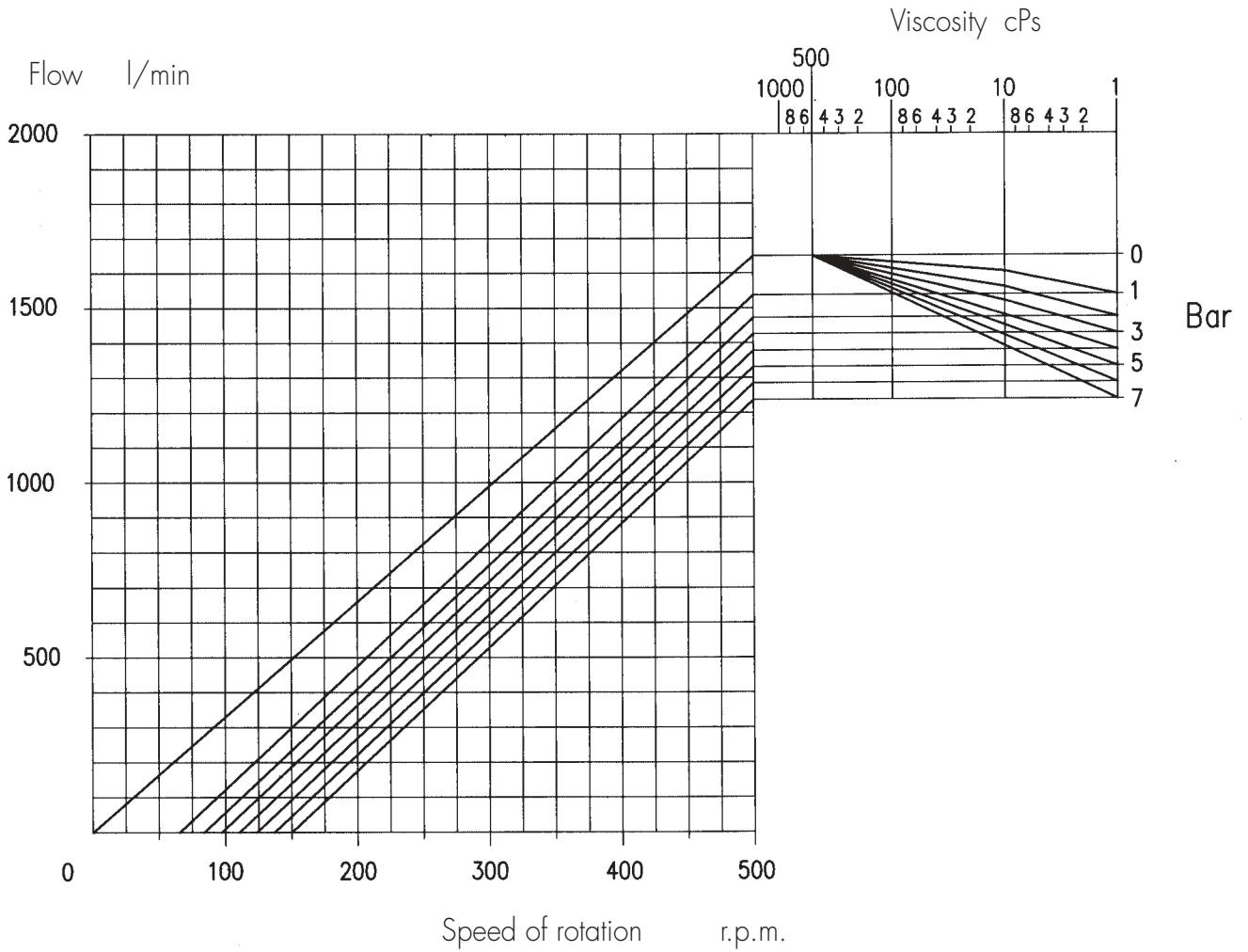

Kw = Absorber power

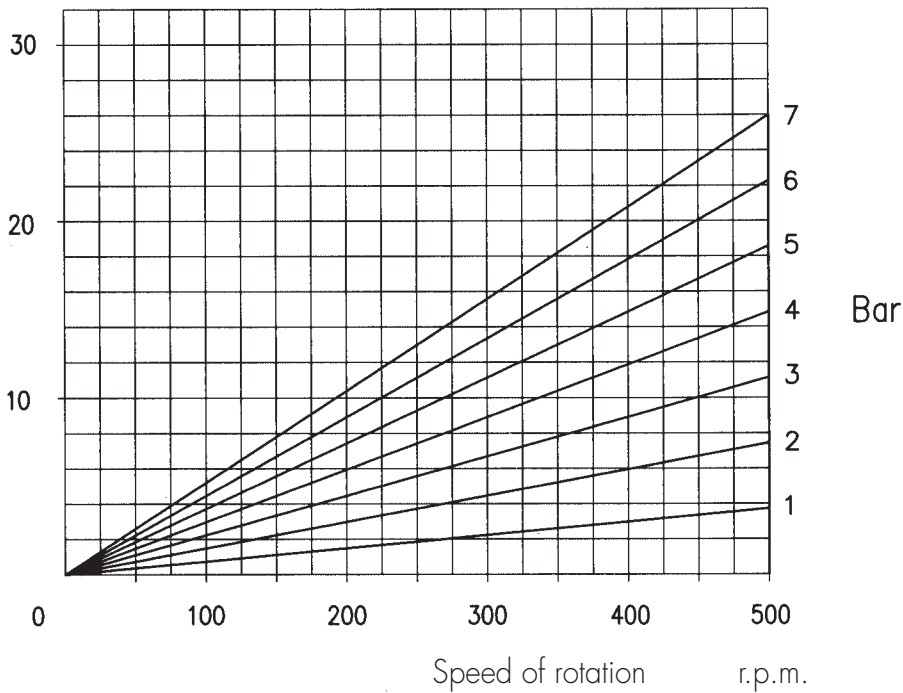

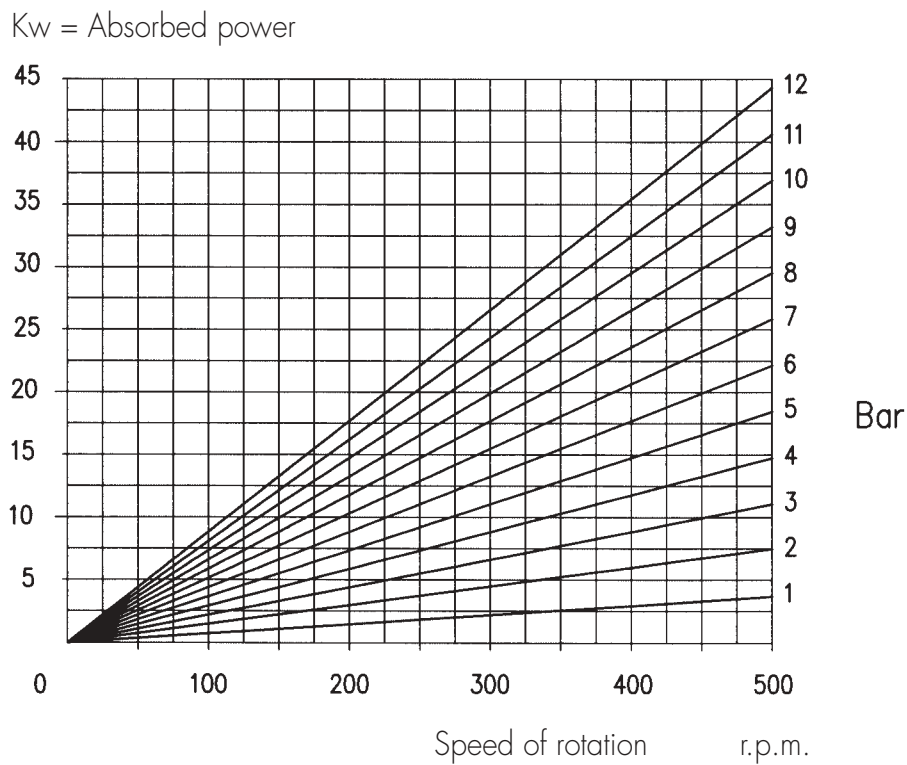
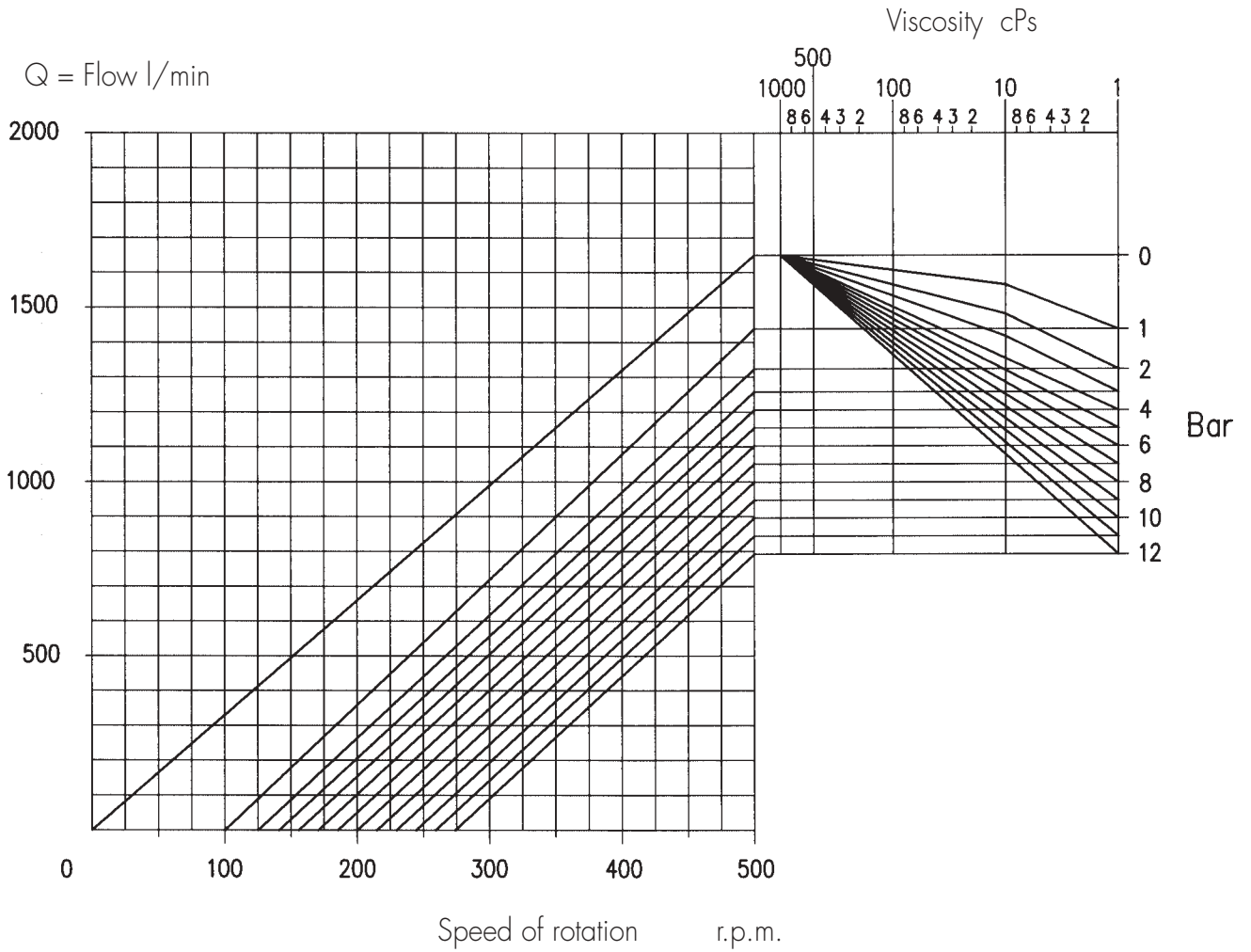

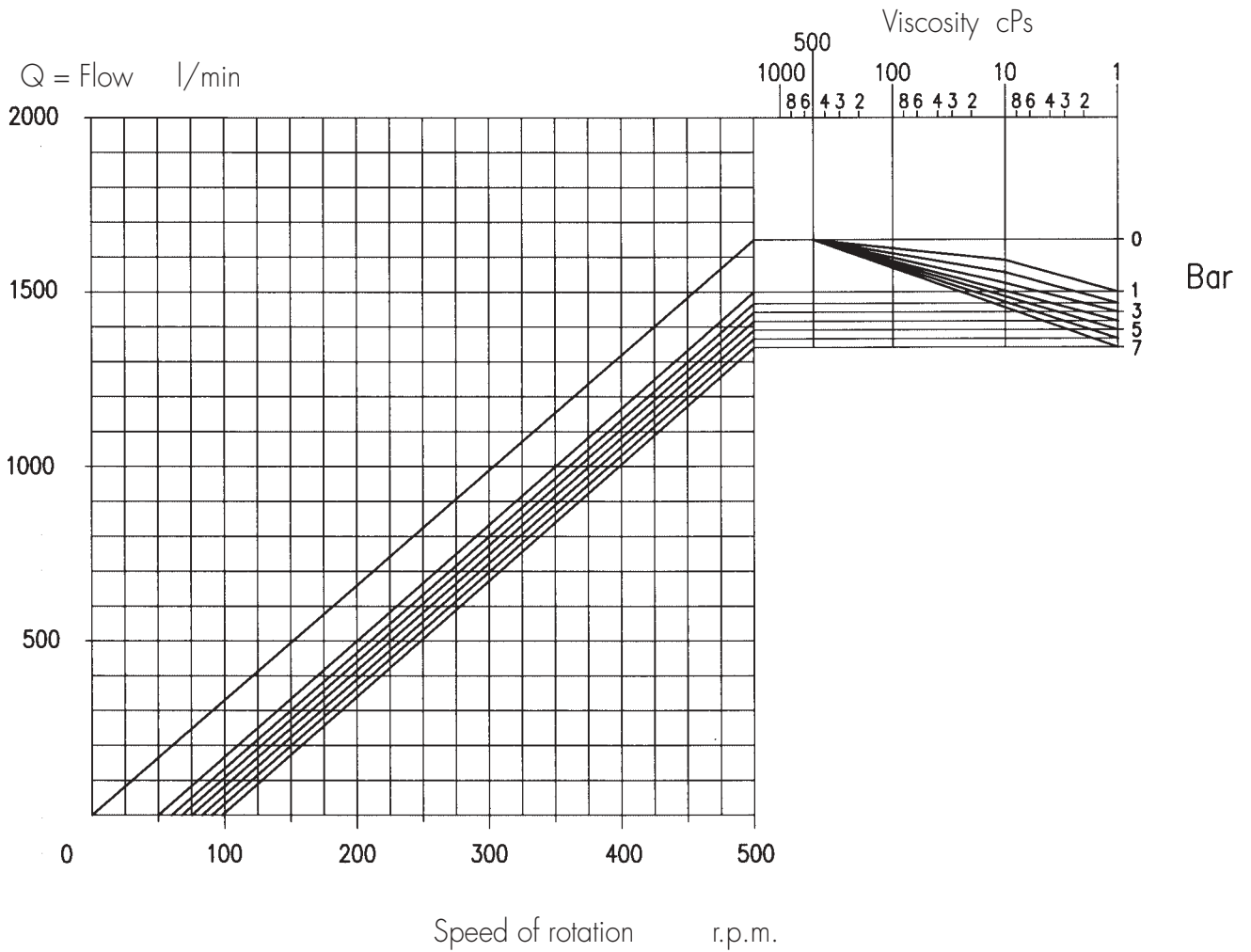

Kw = Absorbed power

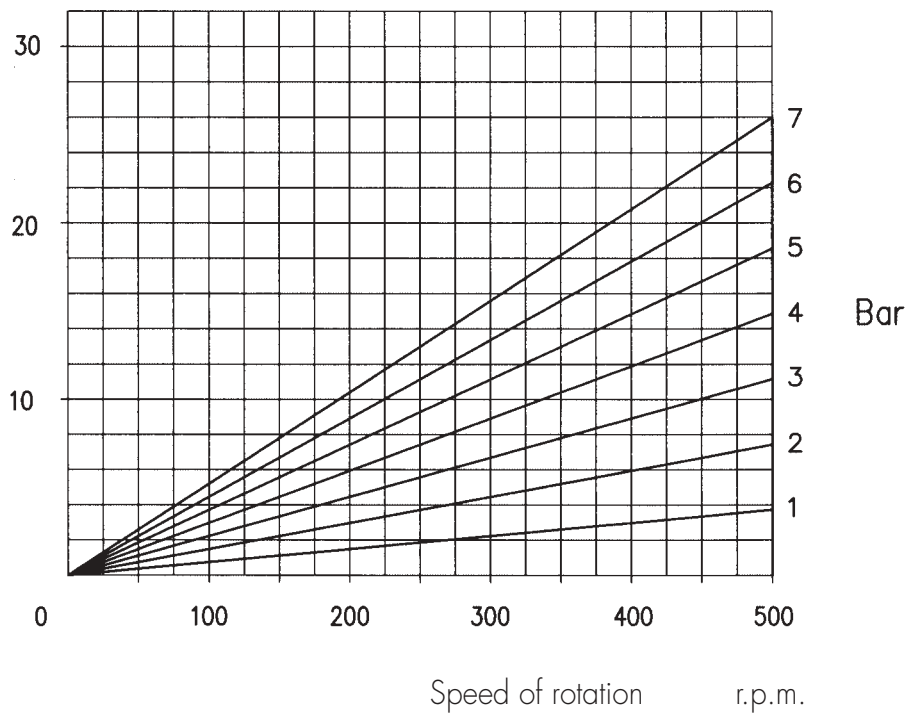

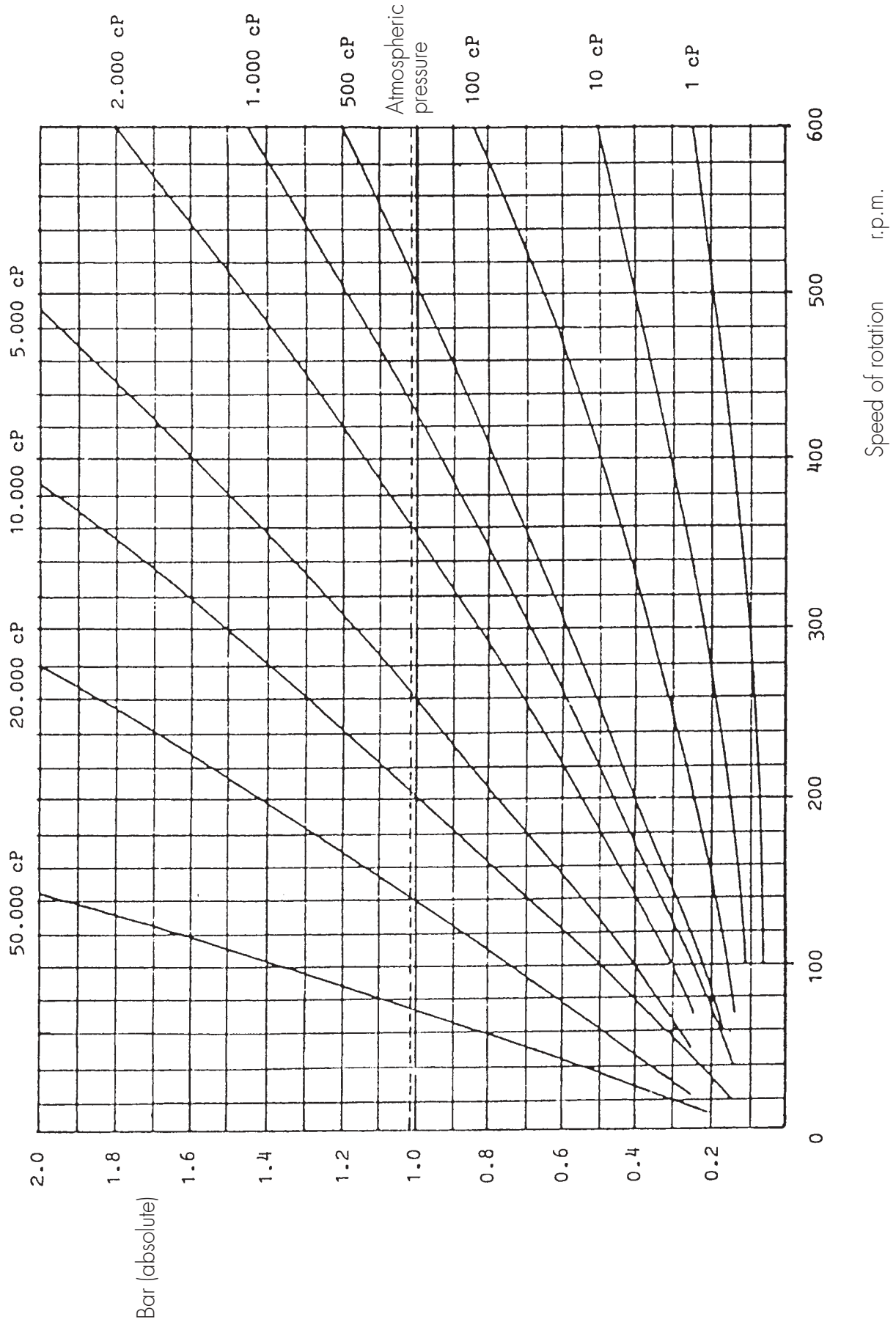

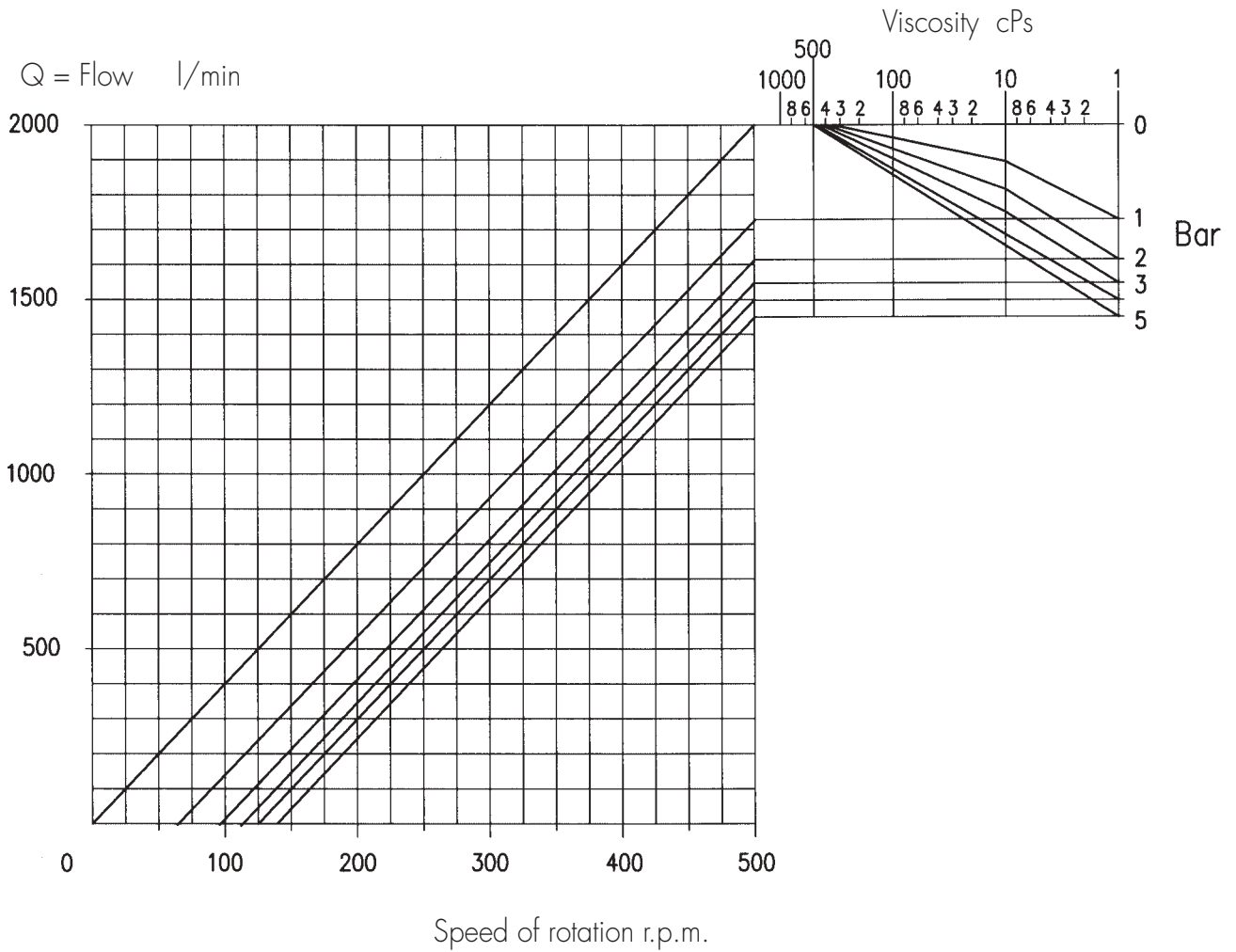

Kw = Absorbed power

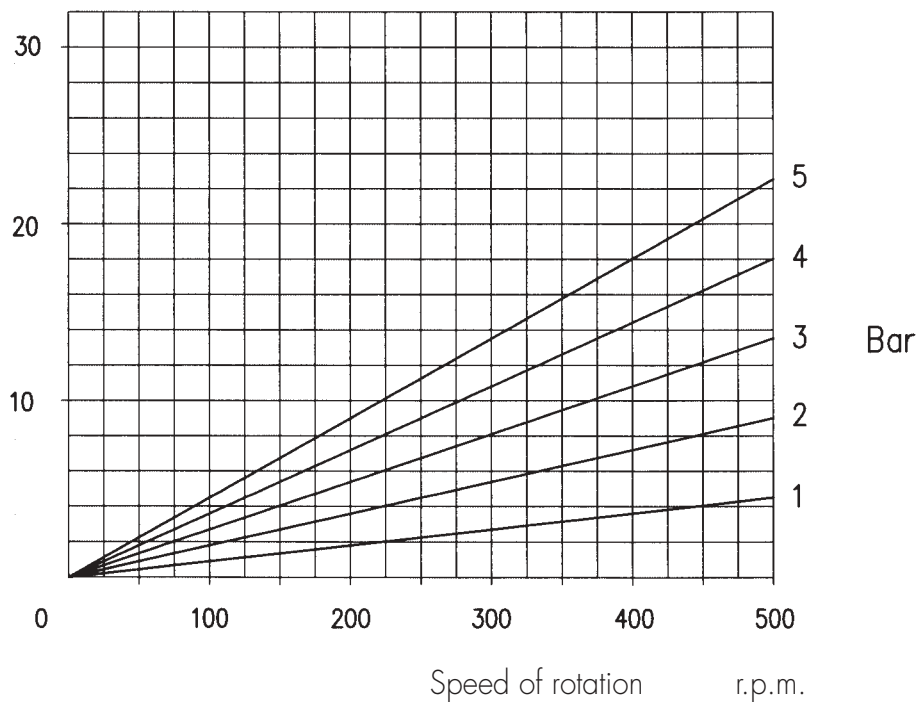



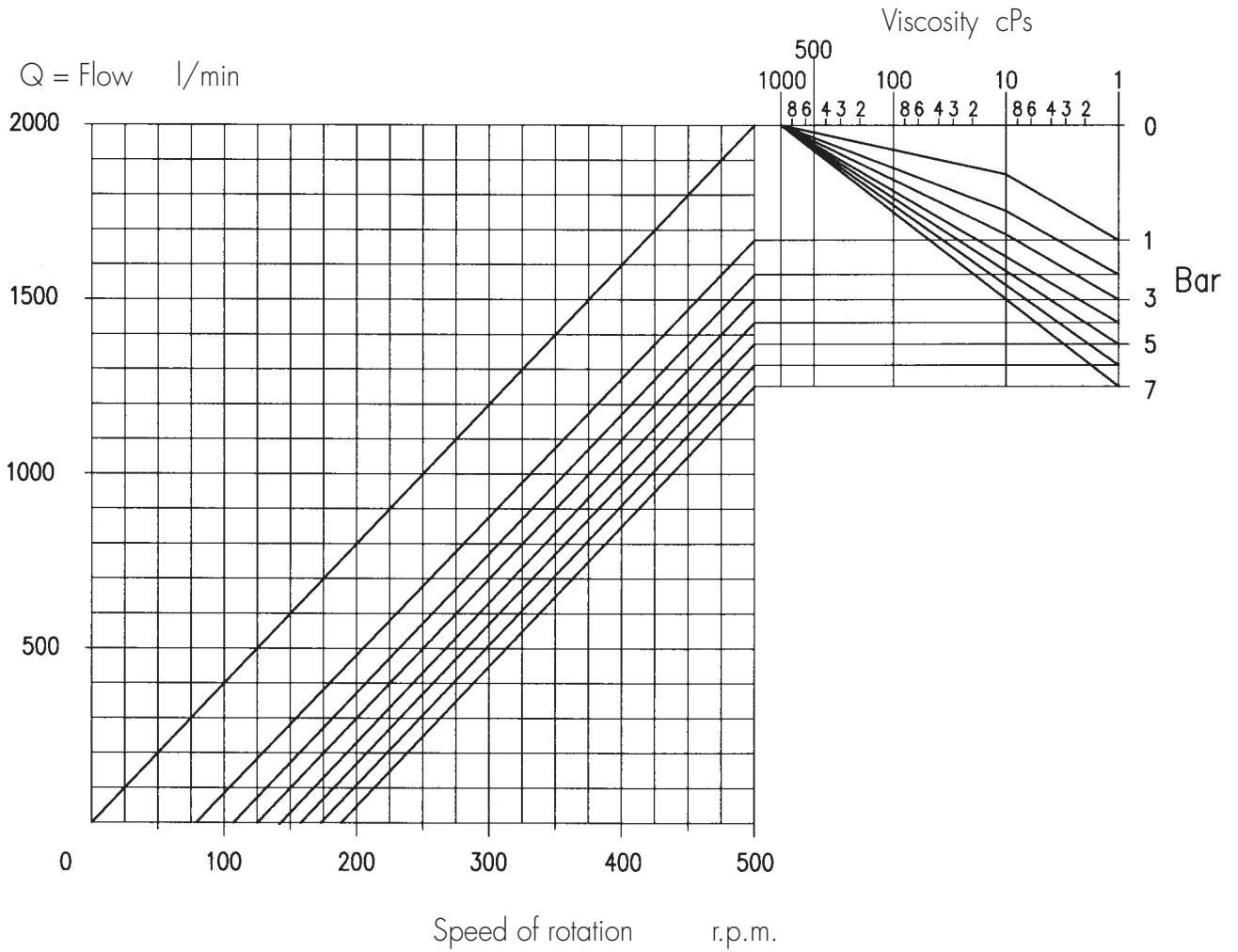

Kw = Absorbed power

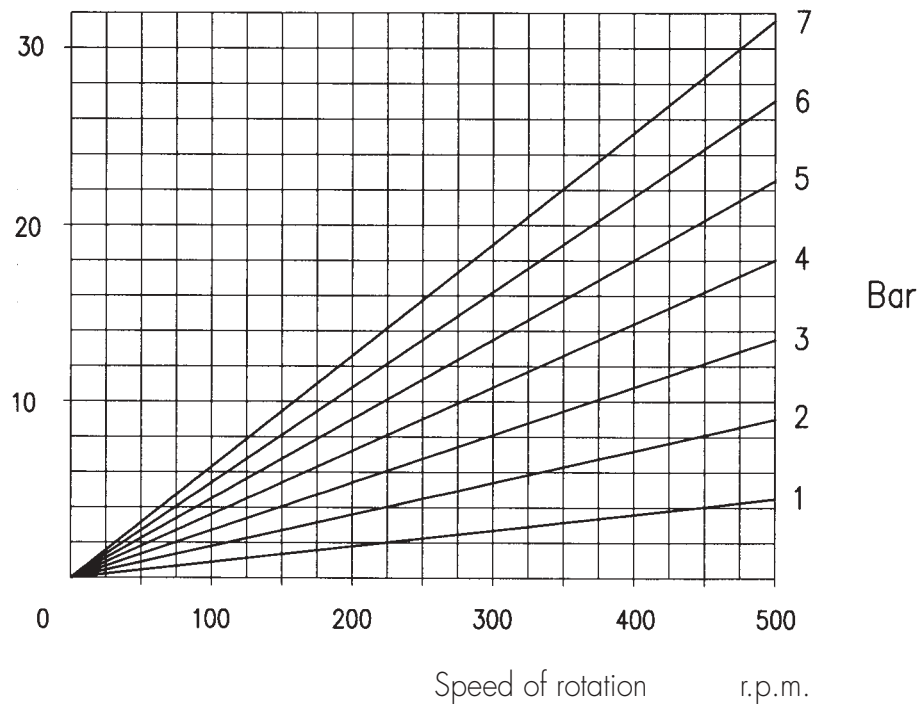

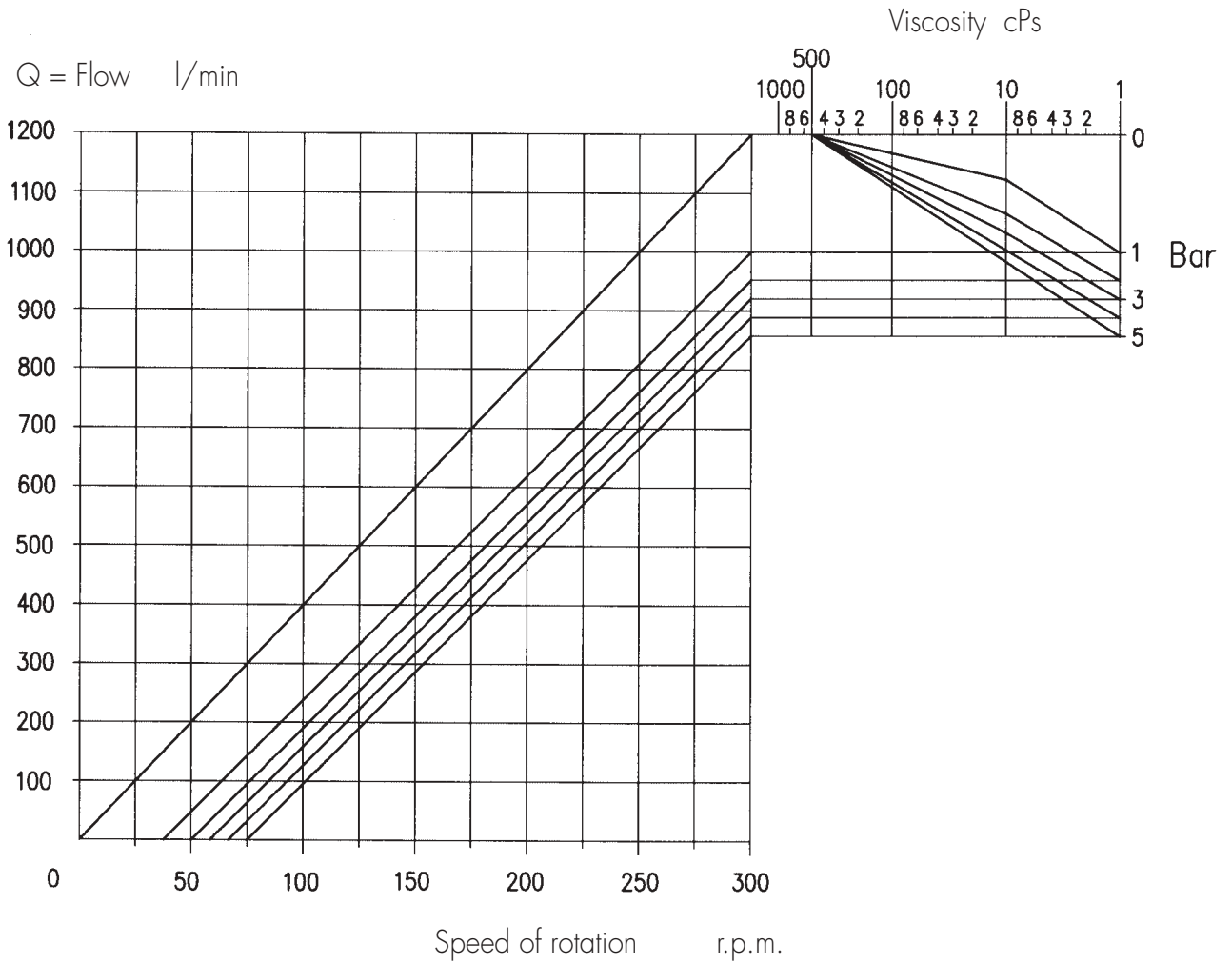

Kw = Absorbed power

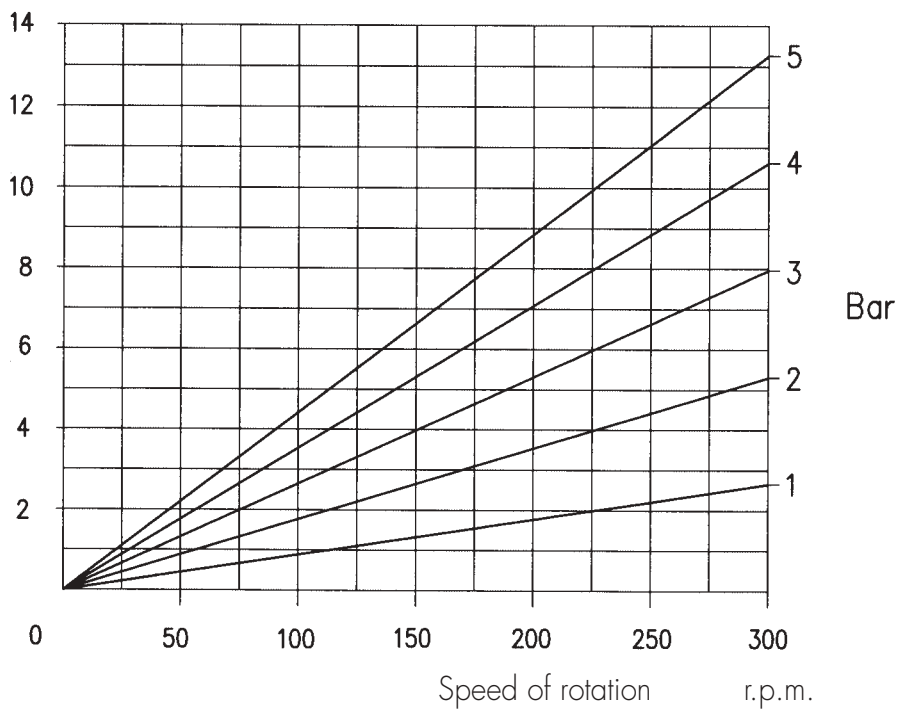

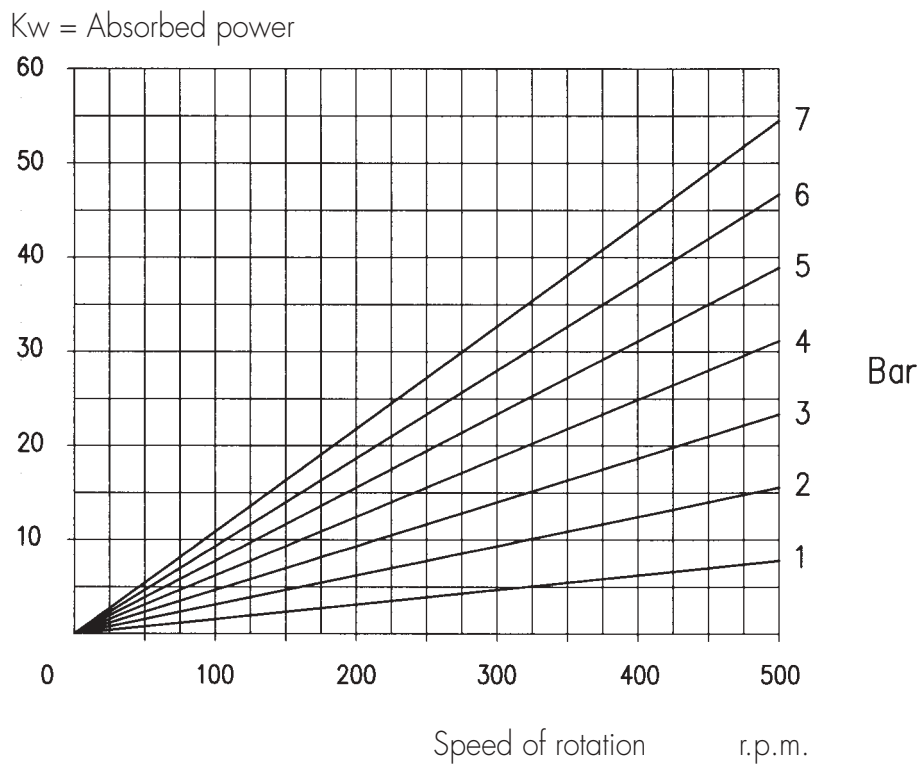
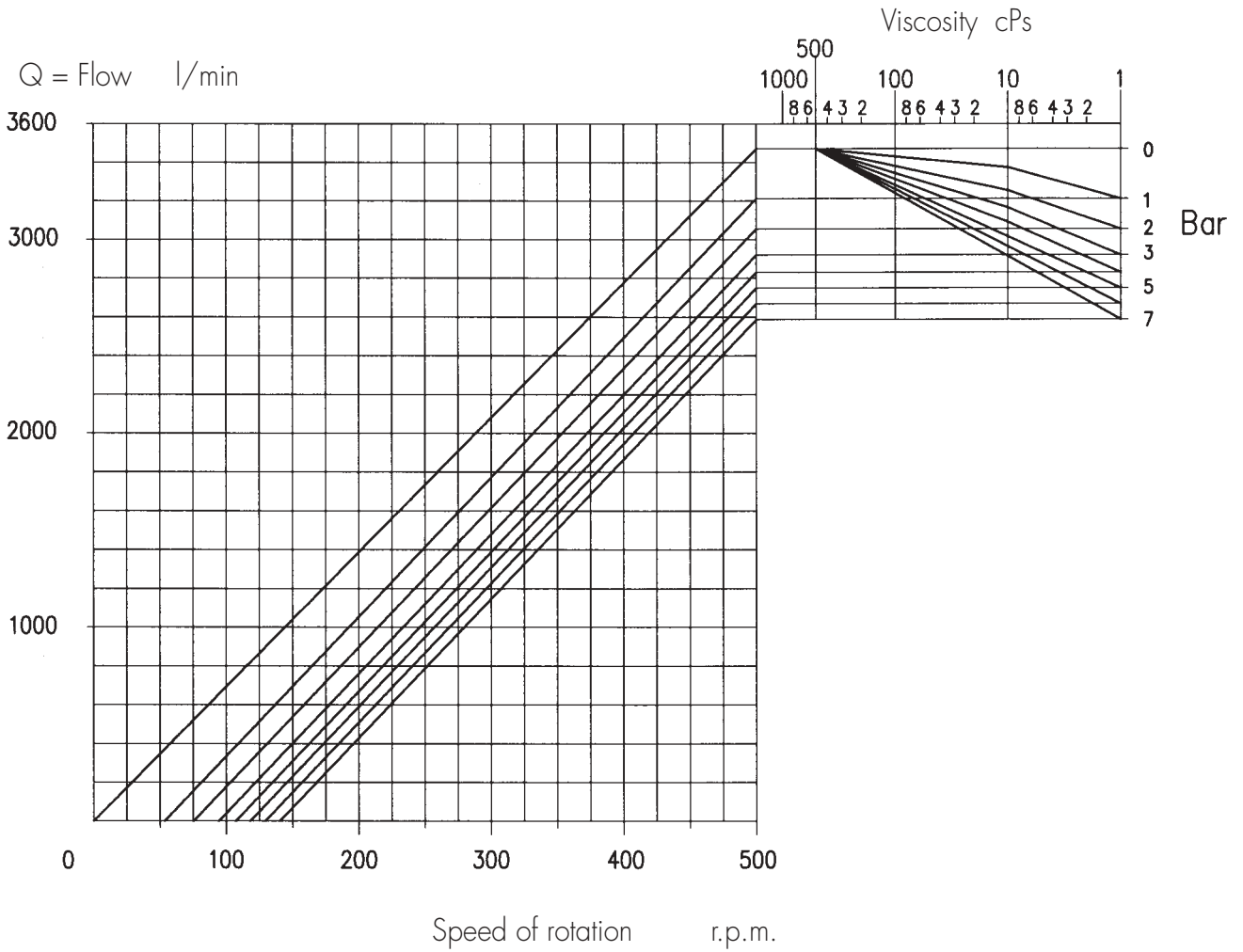

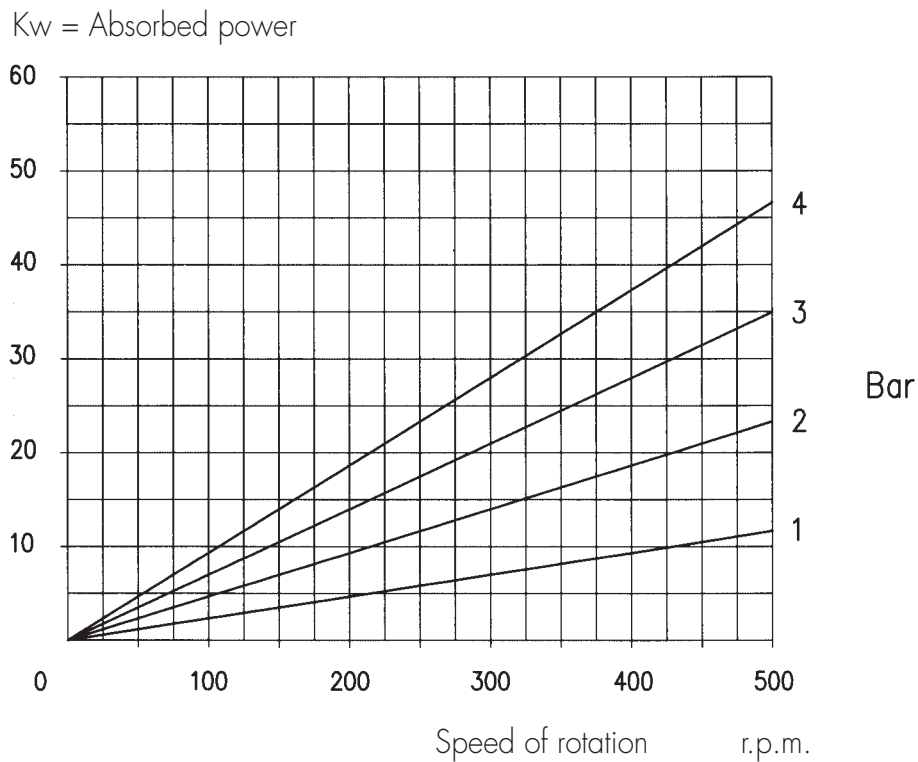
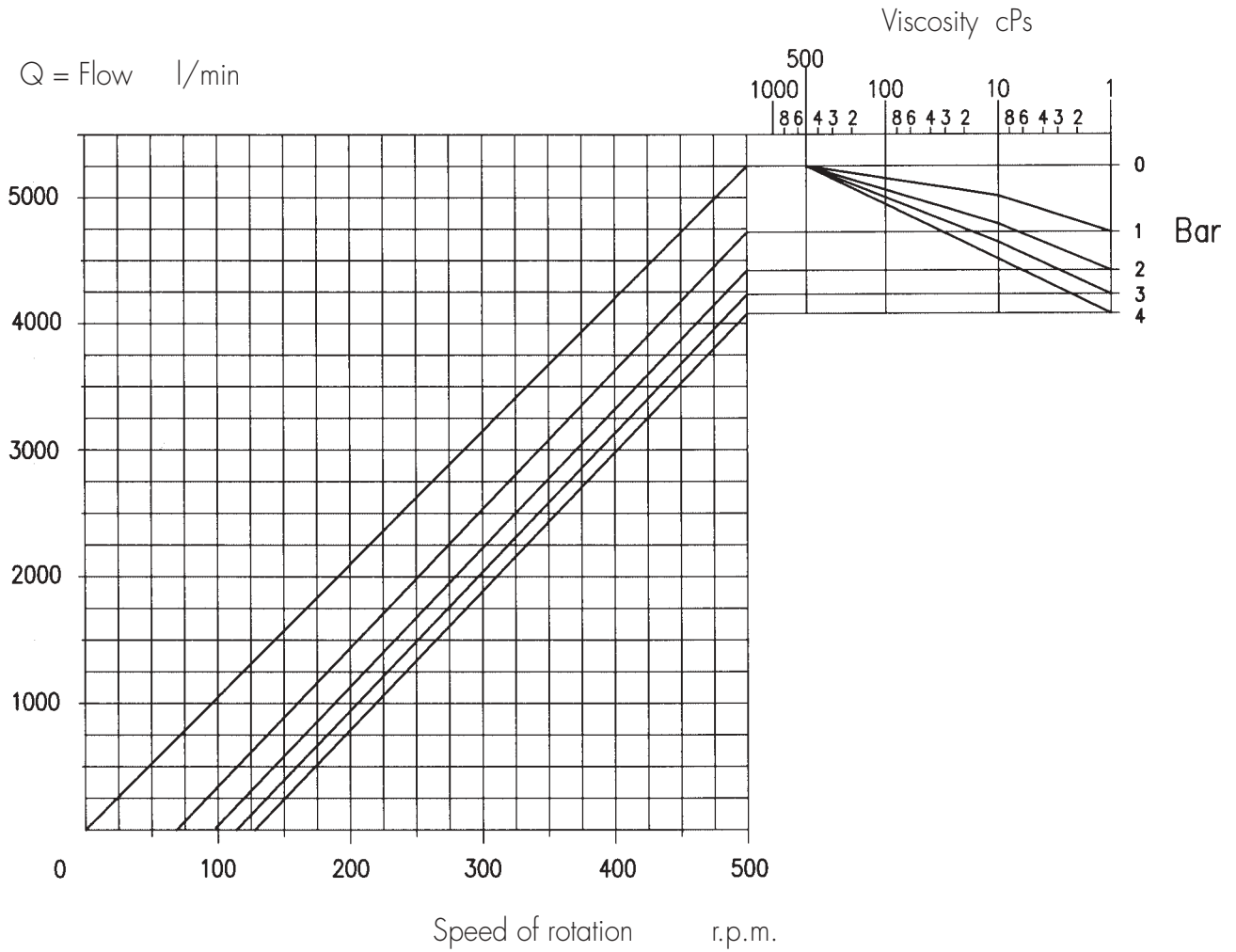

Initially issued Jan. 2, 1995  
U.S. Representative:  
Sanchelima International, Inc.  
1781-83 N.W. 93rd Avenue  
Miami, FL 33172



Authorization No. 810

**This Is To Certify That**

O.M.A.C. SRL POMPE

Via G. Falcone 8, I-42048 Rubiera (RE), ITALY

is hereby authorized to continue to apply the 3-A symbol to the models of equipment, conforming to the 3-A Sanitary Standards for Centrifugal and Positive Rotary Pumps for Milk and Milk Products  
(02-09)

\_\_\_\_\_, set forth below:  
Model Designations Series B (100 - 105 - 110 - 115 - 215 - 220 - 325 - 330 - 430 - 440 - 470 - 490 - 540 - 550 - 660 - 680 )

\_\_\_\_\_ for the twelve months ending January 31, 2001

Date of issuance: October 4, 2000  
*Earl O. Wright*, Secretary.  
3-A SANITARY STANDARDS SYMBOL ADMINISTRATIVE COUNCIL  
\*\*\*\*\*

The issuance of this authorization for the use of the 3-A symbol is based upon the voluntary certification, by the applicant for it, that the equipment listed above complies fully with the 3-A Sanitary Standards designated. Legal responsibility for compliance is solely that of the holder of this Certificate of Authorization, and the 3-A Sanitary Standards Symbol Administrative Council does not warrant that the holder of an authorization at all times complies with the provisions of the said 3-A Sanitary Standards. This in no way affects the responsibility of the 3-A Sanitary Standards Symbol Administrative Council to take appropriate action in cases in which evidence of non-compliance has been established.

**PLANT**

A-Due S.r.l.  
Agriflex S.r.l. GIS S.p.A.  
Arel Control (1971) Ltd  
Asepsystems S.r.l.  
Aseptomag-MTS AG  
Astepo S.r.l.  
Berma S.n.c.  
Bertocchi S.r.l.  
Binacchi & C. S.r.l.  
Bisaro S.r.l.  
Boema S.r.l.  
Brambati S.p.A.  
C.F.C. S.n.c.  
C.M.A.I. Impianti S.r.l.  
Casearmeccanica Vicentina S.n.c.  
Catta 27 S.r.l.  
Color Service S.r.l.  
Comas S.p.A.  
Corob S.p.A.  
Cortellazzi Fintec  
Costec S.r.l.  
Eurotech Process Plants S.r.l.  
Executive S.r.l.  
F.B.R. Elpo S.r.l.  
F.Ili Menozzi S.n.c.  
Farck S.p.A.  
FMC Italia S.p.A.  
Gruppo Bertolaso S.p.A.  
Ing. A. Rossi S.r.l.  
Ing. S. Pancolini S.r.l.  
Lawer S.p.A.  
Magnabosco S.r.l.  
ME.TRA S.p.A.  
Mec Lat Brevetti S.n.c.  
Mecter S.r.l.  
Muvitec S.r.l.  
Niro Soavi S.p.A.  
Nuova Cosmar S.r.l.  
Nuova Maip-Pieralisi S.p.A.  
Off. Mecc. Molteni S.r.l.  
Off. Mecc. Pavese S.n.c.  
Olsa S.p.A.  
Panini S.r.l.  
Pavan S.p.A.  
Pelbo S.r.l.  
Pellacini Sergio & Figli S.a.s.  
Pozzi Elettronica S.r.l.

Procomac S.p.A.  
Reda S.p.A.  
Ronchi Mario S.r.l.  
Rossi & Catelli S.p.A.  
Rota Guido S.r.l.  
Ruffinatti S.p.A.  
Sacma Inox S.n.c.  
Sanovo S.r.l.  
Sasib Proc. & Seam  
Sidam S.r.l.  
Soren S.r.l.  
Technodairy S.n.c.  
Termoelettronica S.p.A.  
Tetra Pack Food Eng. S.p.A.  
TMCI Padovan S.p.A.  
Trivi S.r.l.  
Westfalia Separator  
Zanichelli Meccanica S.p.A.  
Zuris

**FOOD INDUSTRY**

A. Loacker AG-S.p.A.  
Althea S.p.A.  
Amylum Bulgaria - Amylum Hellas  
Balconi S.p.A.  
Barilla Alimentare S.p.A.  
Bauli S.p.A.  
Bestfoods Italia S.p.A.  
Bonomi S.p.A.  
Boschi Luigi & Figli S.p.A.  
Burro delle Alpi S.A.B.A. S.p.A.  
Cabrioni Biscotti S.r.l.  
Caseifici dell'Alta Langa S.r.l.  
Caseificio F.Ili Bergamin S.p.A.  
Columbus S.r.l.  
CO.PAD.OR. S.c.a.r.l.  
CONAR S.c.a.r.l.  
Conserve Italia S.c.a.r.l.  
Cons. Casalasco del Pomodoro  
Dallari Nino & Figli S.n.c.  
Dilat S.p.A.  
Delmonte Italia S.p.A.  
Delmonte Kenia Limited  
Dolmont S.r.l.  
Elah-Dufour S.p.A.

Esselunga S.p.A.  
Euro Cakes S.p.A.  
F.Ili Saclà S.p.A. - F.Ili Carli S.p.A.  
Fattorie Osella S.p.A.  
Ferrero S.p.A.  
Ferruccio Podda S.p.A.  
Forneria Gusparo S.p.A.  
Forneria Lucana S.p.A.  
Fruttageil S.c.a.r.l.  
Greci Ind. Alimentare S.p.A.  
Lat Bri Latticini Brianza S.p.A.  
Leaf Italia (ex Sperlari) S.r.l.  
Menz & Gasser S.p.A.  
Montanari & Gruzza S.p.A.  
Nestlé Italiana S.p.A.  
Nestlé Joe IBC  
P.I.D.A. S.r.l.  
Parmalat S.p.A.  
Pastificio Felicetti S.a.s.  
Pastificio Gazzola S.p.A.  
Pastificio Rana S.p.A.  
Perfetti S.p.A.  
Pre Gel S.p.A.  
Roquette italia S.p.A.  
S.I.P.A. S.p.A.  
Sammontana S.r.l.  
Sedamyl S.p.A.  
Uovador S.r.l.

**BEVERAGE INDUSTRY AND WINE-MAKERS**

Acque Minerali S. Benedetto S.p.A.  
Campari-Crodo S.p.A.  
Cantina Soc. S. Maria la Palma  
Cantine Coop. Riunite S.c.a.r.l.  
Cantine Giacomo Montresor S.p.A.  
Cantine Mezzocorona S.c.a.r.l.  
Caviro S.c.a.r.l.  
Cavit - Cantina Viticoltori  
Coca Coca Bevande Italia S.p.A.  
Distilleria Magnoberta S.p.A.  
F.Ili Giacosa S.n.c.  
Fattoria di Paterno S.n.c.  
Gruppo Coltiva S.c.a.r.l.  
Gruppo Italiano Vini S.c.a.r.l.  
Hellenic Bottling Company S.A.  
Marchesi De Frescobaldi S.p.A.  
Meloni Vini S.r.l.  
Norda S.p.A.  
Pasqua Vigneti e Cantine  
San Pellegrino S.p.A.  
Soc. Gen. Acque Min. "Lete"  
Stock S.p.A.  
Tenute Sella & Mosca S.p.A.  
Terme di Recoaro S.p.A.  
Terre Cortesi Moncaro  
Viña Falernia  
Vitivinicola Mastro Berardino

**CHEMICAL AND PHARMACEUTICAL INDUSTRIES**

Artsana S.p.A.  
Beiersdorf S.p.A.  
Biochimica S.p.A.  
Biofer S.p.A.  
Ceramiche Gardenia-Orchidea S.p.A.  
Co.Ind. S.c.a.r.l. Div. Unichem  
Colgate Palmolive Inc. SA  
Colorificio Paulin S.p.A.  
Deoflor S.p.A.  
Drago S.p.A.  
Emmegi Detergents S.p.A.  
Far. Pro. Modena S.r.l.  
Farmitalia Carlo Erba S.r.l.  
Farmol Safca S.p.A.  
Fater S.p.A.  
Ferrania S.p.A.  
Gruppo Ceramiche Ricchetti S.p.A.  
Henkel S.p.A.  
Huntsman S.r.l.  
Hydra Farmacosmetici S.r.l.  
I.M.P. Imballaggi mat. plastiche S.p.A.  
Iris Ceramica S.p.A.  
Jefagro Technologies Inc.  
Kerakoll S.p.A.  
L. Manetti & H. Roberts & C. S.p.A.  
L'Oreal Saipo Industriale S.p.A.  
Lab. Chimico-Farmaceutico

Sammarinese SA  
Lamberti S.p.A.  
Lever Fabergé Italia S.p.A.  
Madel S.p.A.  
Manifatture Tabacchi  
Farmacia S.p.A.  
Procter & Gamble S.p.A.  
Tecmomed S.r.l.  
Vetagro S.r.l.  
Vis Farmaceutici S.p.A.

**TANKERS**

Adami Autotrasporti S.r.l.  
Autotrasporti Liverani S.r.l.  
F.Ili Berto Luigi & Bruno S.n.c.  
Hochstaffl GMBH  
Rodella Trasporti S.r.l.  
S.A.S. Soc. Aut. Speciali S.p.A.



**OMAC S.r.l. POMPE** Via G. Falcone, 8 - 42048 RUBIERA (RE) - ITALY  
TEL. 0522 629371-629923 - FAX 0522 628980  
[www.omacpompe.com](http://www.omacpompe.com) - E-mail: [commerciale@omacpompe.com](mailto:commerciale@omacpompe.com)